



U p d a t e
2 0 1 7

BONALDO

U p d a t e
2 0 1 7

BONALDO

PHOTO INDEX

2

TAVOLI / TABLES
PAG 6-7

BIG TABLE **pag. 38-41**
 COP **pag. 8-19**
 MILLE **pag. 42-45**
 ORIGAMI **pag. 20-29**
 TRULY **pag. 30-37**

TAVOLI XS / XS TABLES
PAG 46-47

BIG TABLE **pag. 54-59**
 NOA **pag. 48-53**
 ORIGAMI **pag. 60-65**

SEDIE E SGABELLI /
CHAIRS AND STOOLS
PAG 66-67

BAHIA **pag. 68-71**
 FILLY UP TOO **pag. 94-95**
 GILDA **pag. 90-91**
 HERON **pag. 72-75**
 IDOLE **pag. 92-93**
 KETCH LOUNGE **pag. 86-87**
 LIAS **pag. 76-79**
 LIRY **pag. 80-83**
 MISS KETCH **pag. 84-85**
 MISS LAMINA **pag. 88-89**

COMPLEMENTI / ACCESSORIES
PAG 96-97

ARBOR **pag. 110-113**
 ASSEMBLAGE **pag. 118-121**
 DOPPLER LIGHT **pag. 128-129**
 DOPPLER SIDEBBOARD **pag. 102-105**
 MILLE CONSOLE **pag. 132-135**
 MUFFIN LAMP **pag. 126-127**
 NEMESI / NEMESI LIGHT **pag. 114-117**
 ORIGAMI CONSOLE **pag. 130-131**
 RAIN **pag. 106-109**
 SHADE **pag. 98-101**
 THEDUCK **pag. 122-125**

DIVANI / SOFAS
PAG 136-137

COLORS **pag. 146-157**
 LOVY **pag. 158-163**
 SKID **pag. 138-145**

PHOTO INDEX

POLTRONE / ARMCHAIRS
PAG 164-165

ALFIE ARM **pag. 184-185**
 ARNO **pag. 176-177, 182**
 BODO **pag. 180-181, 182**
 BRUNO **pag. 178-179, 183**
 EDDY **pag. 166-171**
 LOCK **pag. 172-175**

LETTI E COMPLEMENTI LETTO /
BEDS AND BED ACCESSORIES
PAG 186-187

BLANKET **pag. 188-193**
 GALA **pag. 196-197**
 WAI **pag. 194-195**

3

A CATALOGUE IS A MAP.

A description that requires beautiful pictures and photographs that have been taken properly, with the right light, the appropriate colours, at scrupulously-studied angles.

Yet as for every map, there is a territory behind it. With its roads, which are often paths; with its points of reference, with its specific features.

For a company, for an industrial manufacturing concern, the territory is the factory itself: its pace, its requirements, its machines and technology, its people.

People who meet up with other people - the designer with the prototyper, the marketing manager with the architect, the head of production with the worker – tracing paths, routes that lead from the idea, from the initial concept, to the end product.

Products such as tables, chairs, beds, armchairs, sofas, accessories... which are explored, before being brought to life, from every possible Products that are exhibited

and admired across the globe. Because the territory of a factory does not keep to the confines of the production site, indeed it crosses over them, and shifts them continuously. Yet only if this merger of people, technology, and know-how leads to the creation of objects capable of making a stand as genuine icons.

These pages, which show the paths taken in 2017, represent a new maturity reached by Bonaldo, ranging from the Cop table by Roberto Paoli to the Origami table by Gino Carollo; from the Assemblage coffee tables by Alain Gilles to the Shade sideboard by Giuseppe Viganò; from the Bahia chair by Mauro Lipparini to the Liry chair by Bartoli Design; from the Colors sofa by Sergio Bicego, to the Blanket bed by Alessandro Busana and many more products still...

Bonaldo. 80 years of made in Italy excellence. With a keen look to the rest of the world, always.

UN CATALOGO È UNA MAPPA.

Una descrizione che ha bisogno di immagini e fotografie belle, ben fatte, con la giusta luce, con i colori appropriati, con le angolature ben studiate.

Ma come per ogni mappa, dietro c'è un territorio. Con le sue strade, che spesso sono sentieri; con i suoi punti di riferimento, con le sue specificità.

Per un'azienda, per una realtà industriale manifatturiera, il territorio è la fabbrica stessa: i suoi ritmi, le sue esigenze, le sue macchine e tecnologie, i suoi uomini.

Uomini che si incontrano con altri uomini – il designer con il prototipista, il marketing con l'architetto, il responsabile della produzione con l'operaio – e tracciano sentieri, percorsi che dall'idea, dalla visione portano poi al prodotto.

Prodotti come tavoli, sedute, letti, poltrone, divani, complementi d'arredo... esplorati, prima di essere realizzati, da ogni possibile punto di vista: la funzionalità, l'estetica, il colore, la forma, l'utilizzo.

Prodotti esposti, ammirati in tutto il

mondo. Perché il territorio di una fabbrica non rispetta i confini del sito produttivo, anzi li travalica, li sposta continuamente. Ma solo se da quell'unione di uomini, tecnologie, saper fare nascono degli oggetti capaci di imporsi come vere e proprie icone.

In queste pagine, i percorsi del 2017, una vera e propria prova di maturità di Bonaldo, che spaziano dal Tavolo Cop di Roberto Paoli al tavolo Origami di Gino Carollo; dai tavolini Assemblage di Alain Gilles alla Madia Shade di Giuseppe Viganò; dalla sedia Bahia di Mauro Lipparini alla sedia Liry di Bartoli Design; dal divano Colors di Sergio Bicego, al letto Blanket di Alessandro Busana e tanti altri ancora...

Bonaldo. 80 anni di made in Italy. E uno sguardo sempre aperto sul mondo.

TAVOLI | TABLES

BIG TABLE
design Alain Gilles

COP
design Roberto Paoli

MILLE
Bartoli Design

ORIGAMI
design Gino Carollo

TRULY
design Mauro Lipparini

COP

design Roberto Paoli

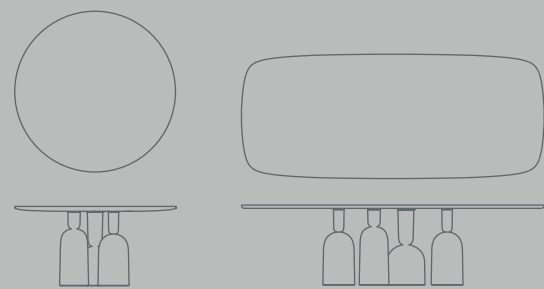











ORIGAMI

design Gino Carollo

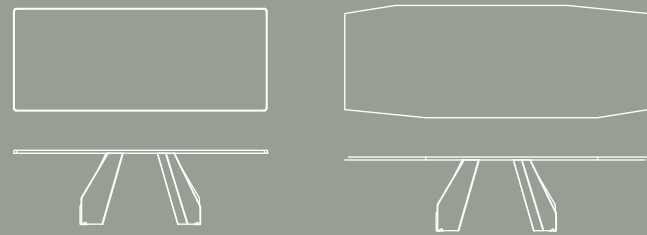





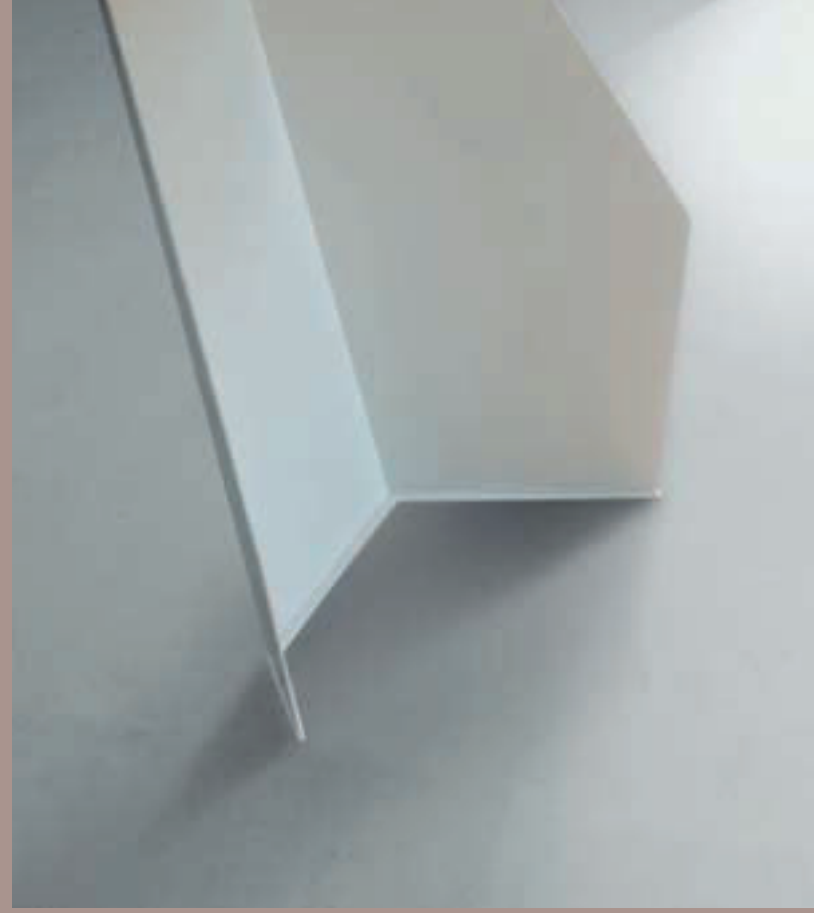



TRULY
design Mauro Lipparini

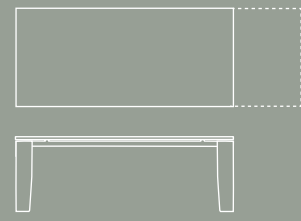





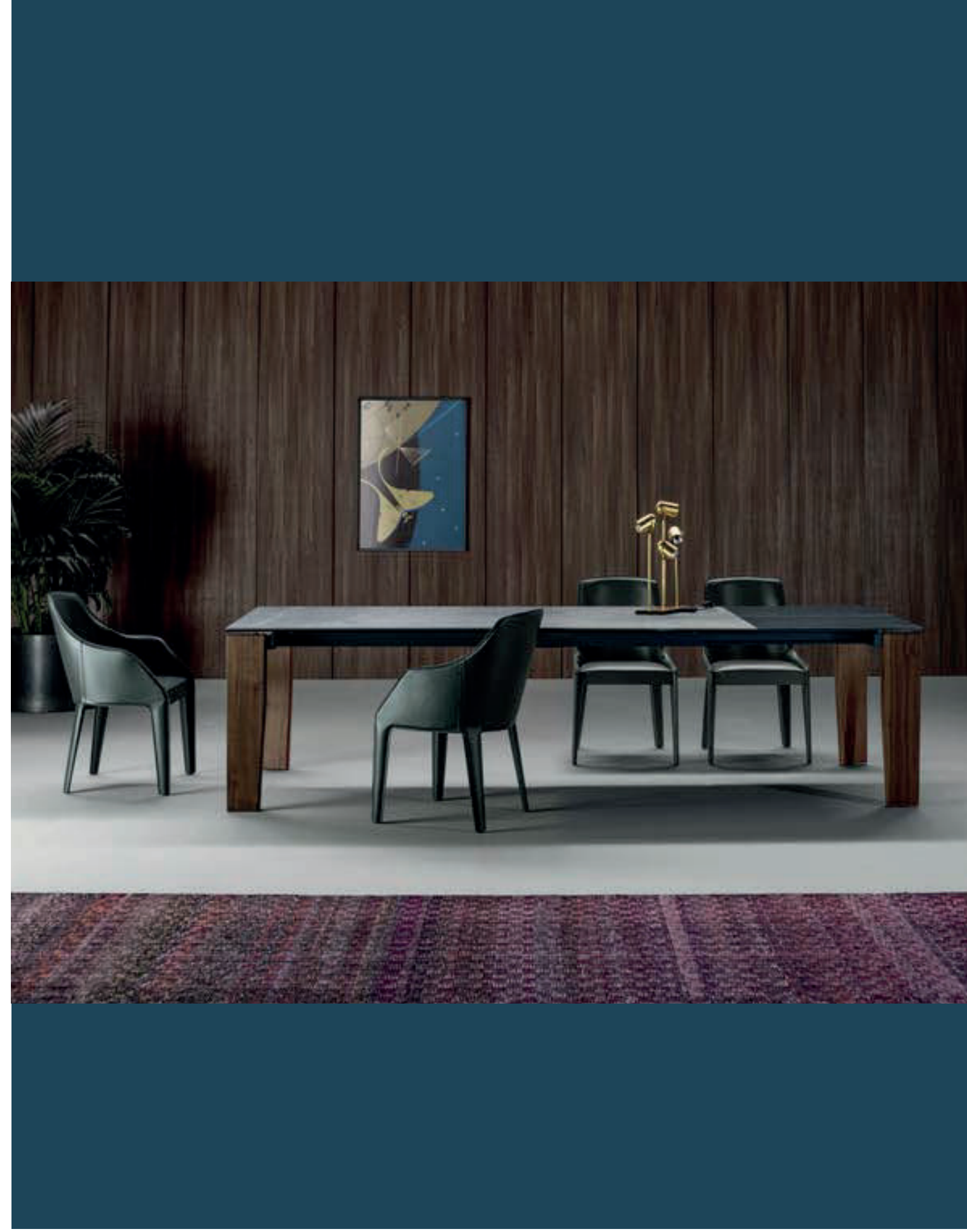

BIG TABLE

design Alain Gilles

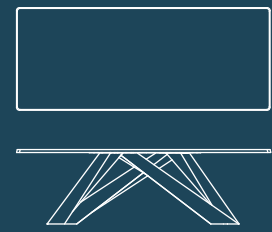



MILLE
Bartoli Design

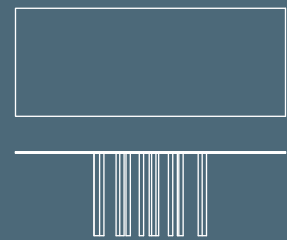



TAVOLI XS | XS TABLES

BIG TABLE
design Alain Gilles

NOA
Bartoli Design

ORIGAMI
design Gino Carollo

NOA
Bartoli Design

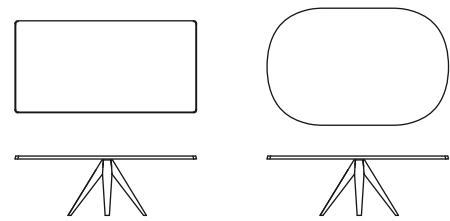





BIG TABLE

Alain Gilles

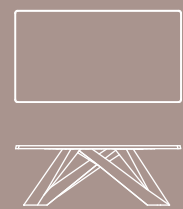





ORIGAMI

Gino Carollo

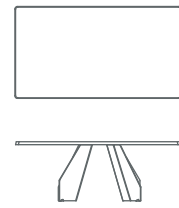





SEDIE E SGABELLI CHAIRS AND STOOLS

BAHIA
design Mauro Lipparini

FILLY UP TOO
Bartoli Design

GILDA

HERON
design Mauro Lipparini

IDOLE
design Dondoli e Pocci

KETCH LOUNGE
Bartoli Design

LIAS
design Gino Carollo

LIRY
Bartoli Design

MISS KETCH
Bartoli Design

MISS LAMINA
design Mauro Lipparini

BAHIA

Mauro Lipparini





HERON

Mauro Lippardini

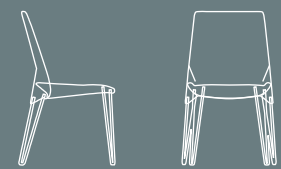



LIAS

Gino Carollo

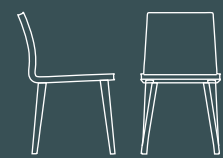

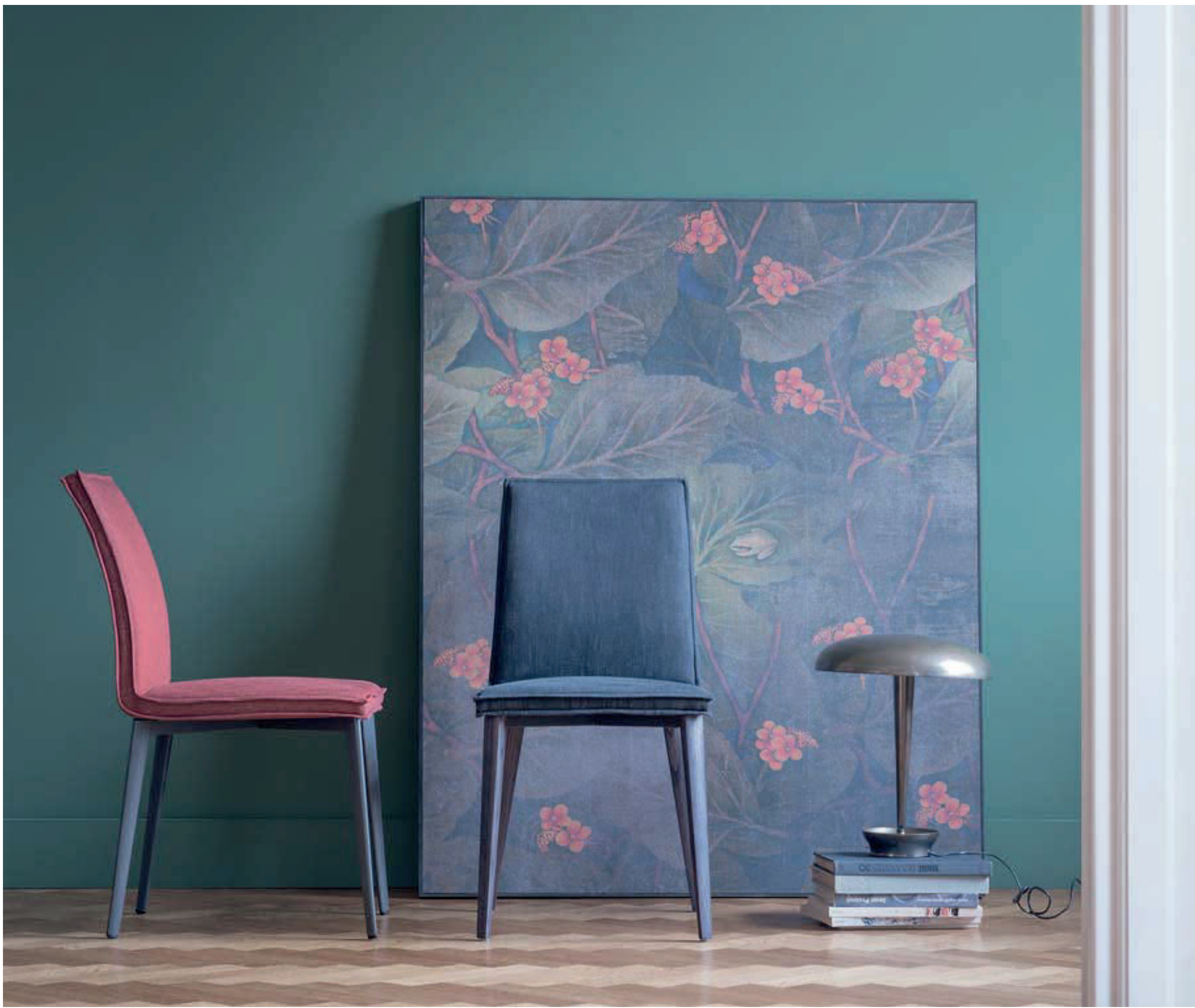

LIRY, LIRY UP

Bartoli Design





MISS KETCH

Bartoli Design

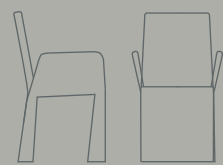

KETCH LOUNGE

Bartoli Design

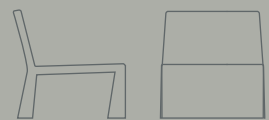

MISS LAMINA

Mauro Lipparini



GILDA

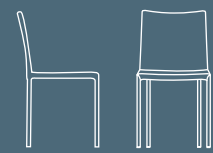

IDOLE

Dondoli e Pocci

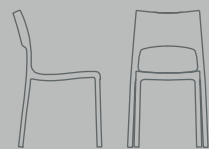

FILLY UP TOO

Bartoli Design



COMPLEMENTI | ACCESSORIES

ARBOR
design Dondoli e Pocci

ASSEMBLAGE
design Alain Gilles

DOPPLER LIGHT
design Giuseppe Viganò

DOPPLER SIDEBOARD
design Giuseppe Viganò

MILLE CONSOLE
Bartoli Design

MUFFIN LAMP
design Ryosuke Fukusada

NEMESI
design Dondoli e Pocci

ORIGAMI CONSOLE
design Gino Carollo

RAIN
design Gino Carollo

SHADE
design Giuseppe Viganò

THEDUCK
design Alessandro Busana

SHADE

Giuseppe Viganò

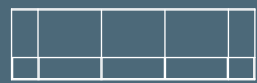

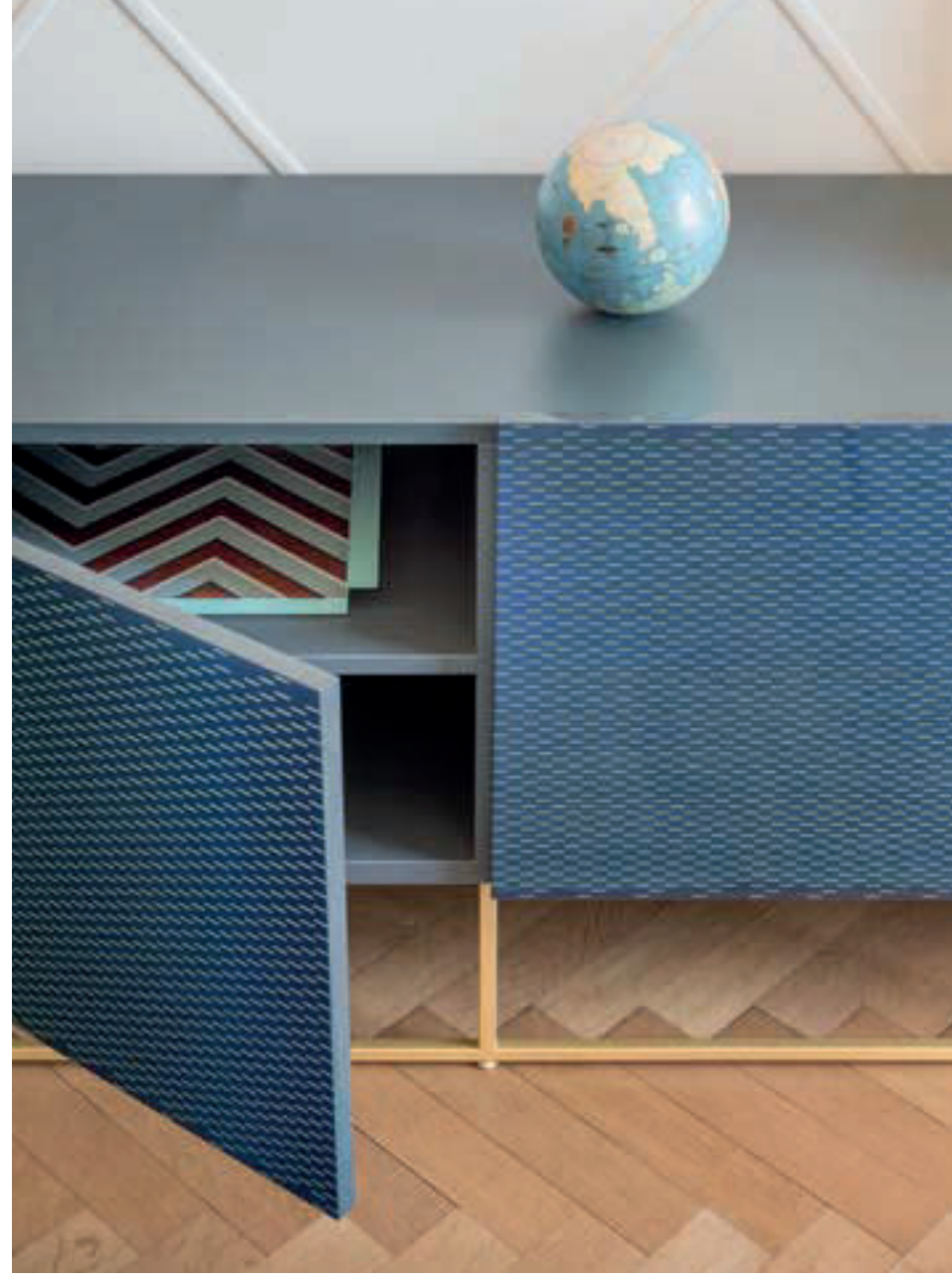

DOPPLER SIDEBOARD

Giuseppe Viganò

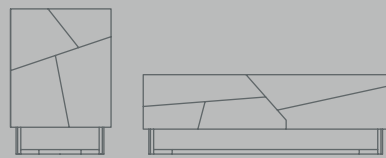

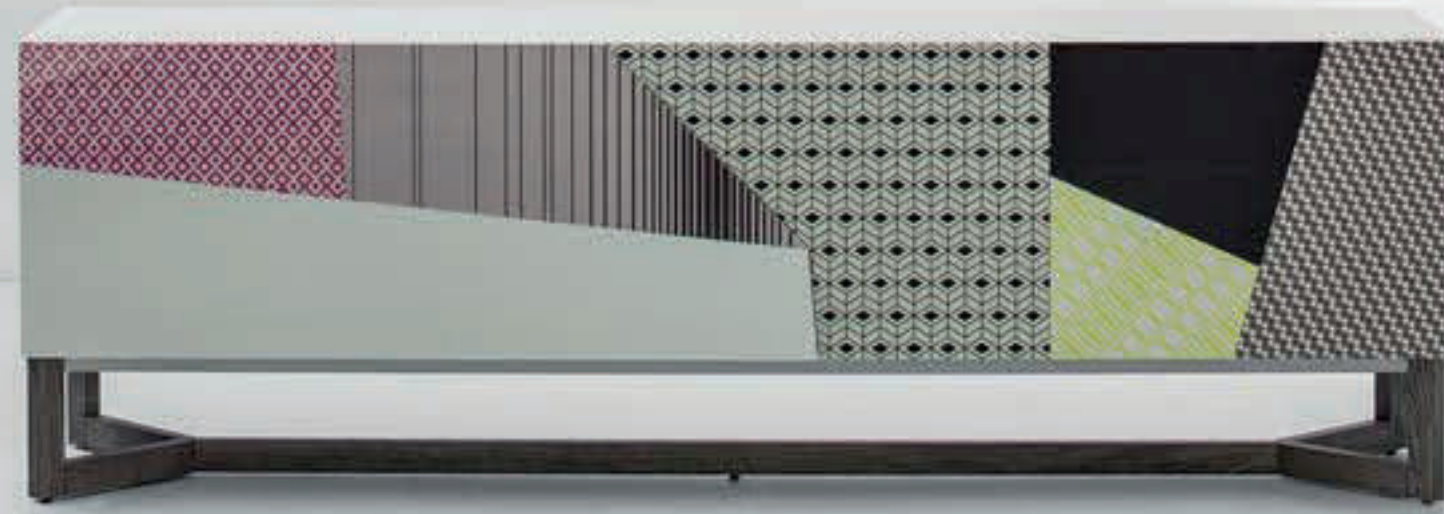

RAIN

Gino Carollo

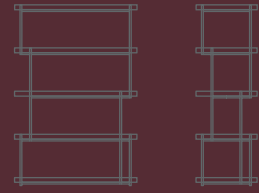



ARBOR

Dondoli e Pocci

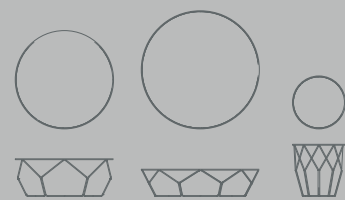



NEMESI
NEMESI LIGHT
Dondoli e Pocci



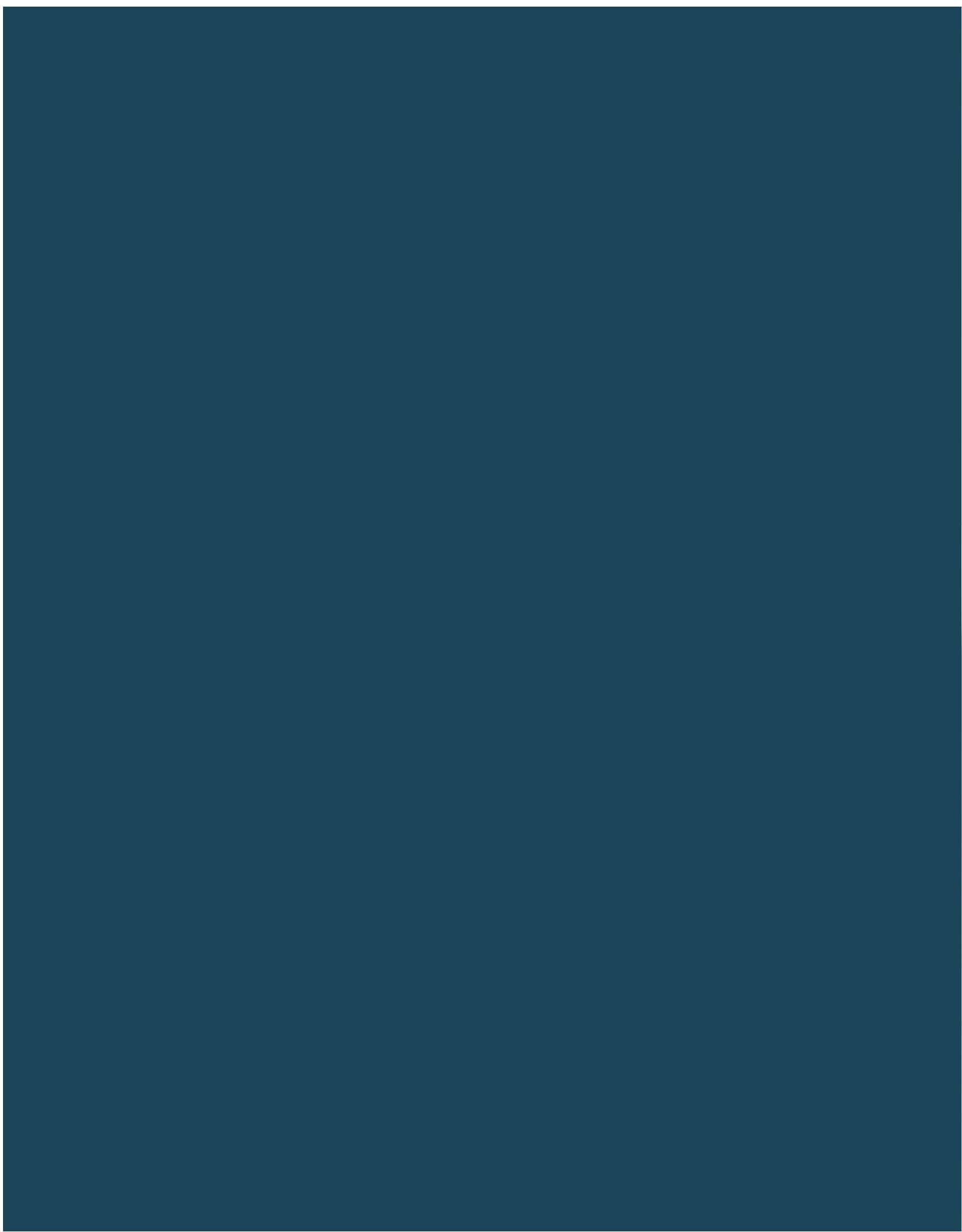

ASSEMBLAGE

Alain Gilles

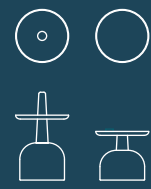

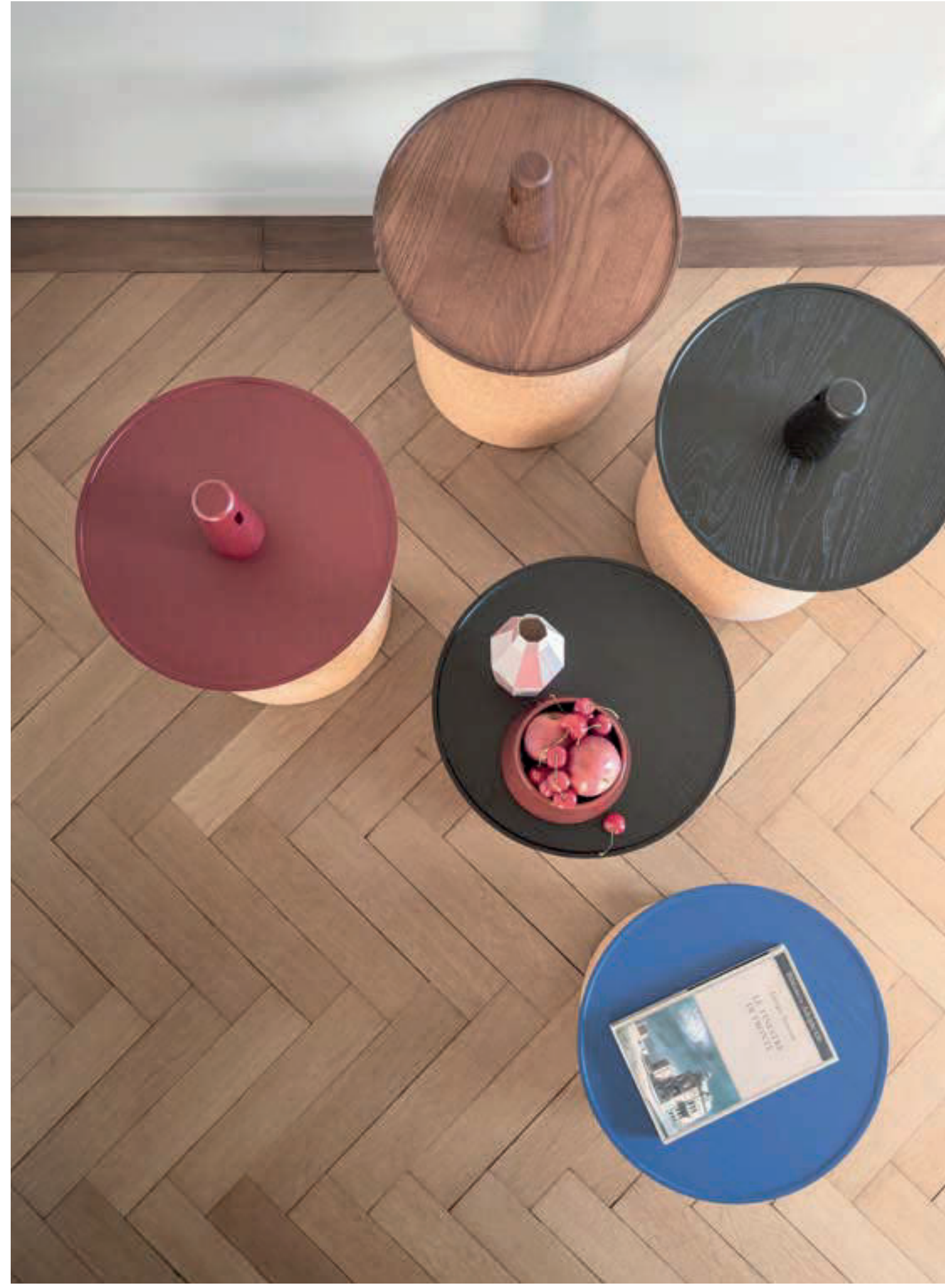

THEDUCK

Alessandro Busana





MUFFIN LAMP

Ryosuke Fukusada



DOPPLER LIGHT

Giuseppe Viganò



ORIGAMI CONSOLE

Gino Carollo



MILLE CONSOLE

Bartoli Design





DIVANI | SOFAS

COLORS
design Sergio Bicego

LOVY
design Sergio Bicego

SKID
design Giuseppe Viganò

SKID

Giuseppe Viganò

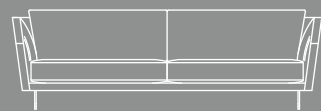







COLORS

Sergio Bicego

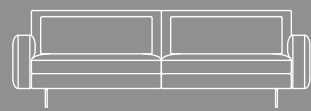











LOVY

Sergio Bicego







POLTRONE | ARMCHAIRS

ALFIE ARM
design Giuseppe Viganò

ARNO
design Mauro Lipparini

BODO
design Mauro Lipparini

BRUNO
design Mauro Lipparini

EDDY
design Alain Gilles

LOCK
design Alessandro Busana

EDDY
Alain Gilles

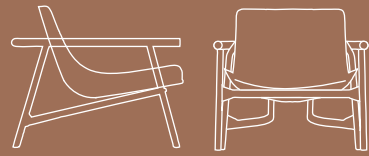





LOCK

Alessandro Busana

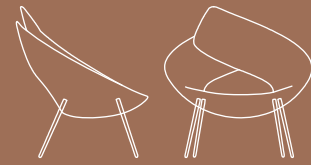



ARNO
Mauro Lipparini

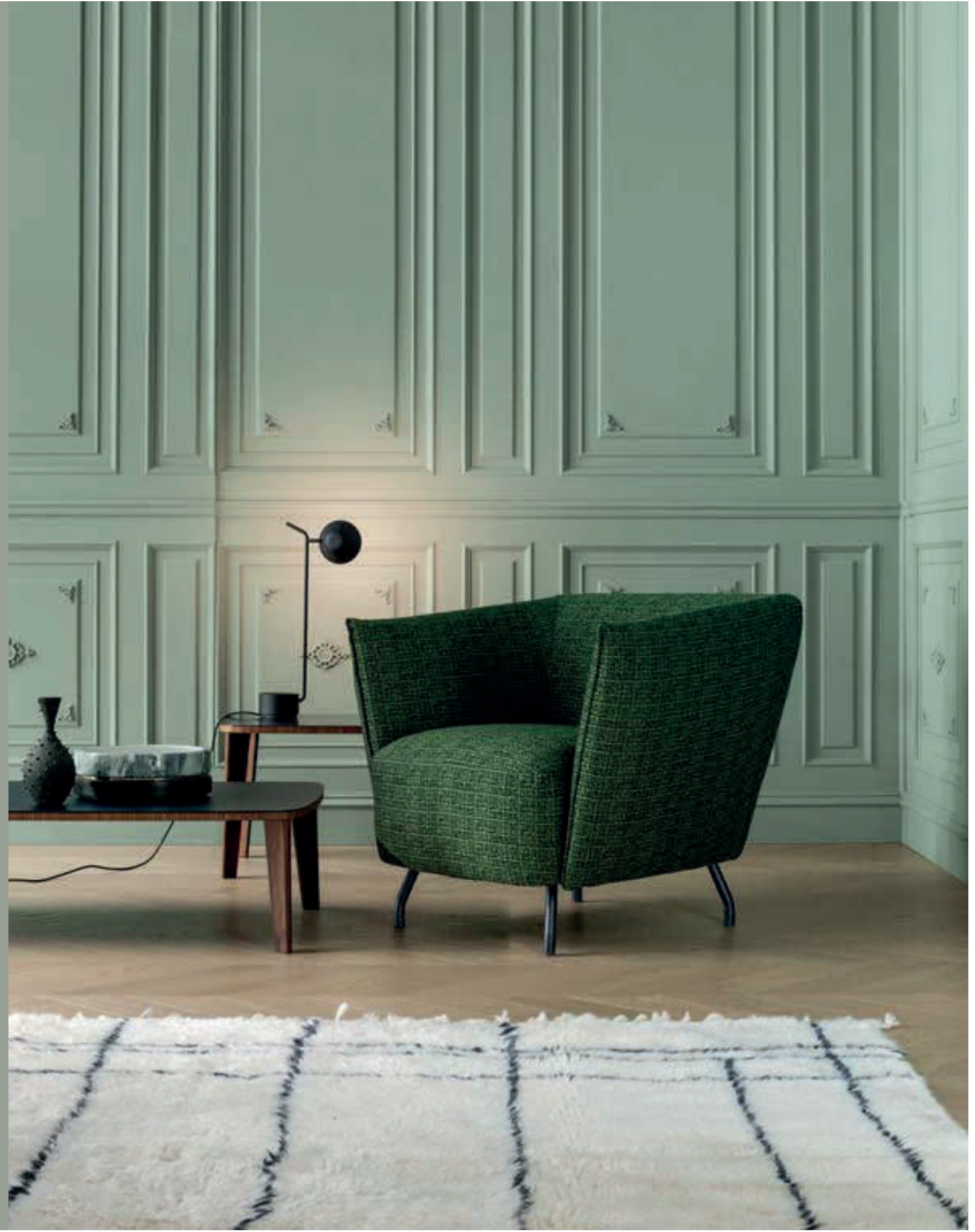
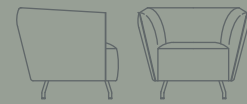

BRUNO

Mauro Lipparini

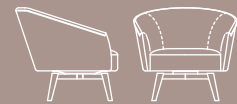

BODO

Mauro Lipparini





ALFIE ARM

Giuseppe Viganò

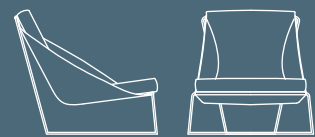

LETTI E COMPLEMENTI LETTO BEDS AND BED ACCESSORIES

BLANKET
design Alessandro Busana

GALA
design Mario Mazzer

WAI
design Mario Mazzer

BLANKET

Alessandro Busana











TECHNICAL INDEX

<u>TAVOLI / TABLES / TISCHE / TABLES</u>	<u>pag. 200-207</u>
BIG TABLE	pag. 200-201
COP	pag. 202
MILLE	pag. 203
ORIGAMI	pag. 204-205
TRULY	pag. 206
<u>TAVOLI XS / XS TABLES / TISCHE XS / TABLES XS</u>	<u>pag. 208-213</u>
BIG TABLE	pag. 208-209
NOA	pag. 210-211
ORIGAMI	pag. 212-213
<u>SEDIE E SGABELLI / CHAIRS AND STOOLS / STÜHLE UND HOCKER / CHAISES ET TABOURETS</u>	<u>pag. 214-218</u>
BAHIA	pag. 214
FILLY UP TOO	pag. 218
GILDA	pag. 214
HERON	pag. 215
IDOLE	pag. 215
KETCH LOUNGE	pag. 216
LIAS	pag. 217
LIRY	pag. 217
MISS KETCH	pag. 216
MISS LAMINA	pag. 218
<u>COMPLEMENTI / ACCESSORIES / EINRICHTUNGSGEGENSTÄNDE / ACCESSOIRES</u>	<u>pag. 220-227</u>
ARBOR	pag. 223
ASSEMBLAGE	pag. 223
DOPPLER LIGHT	pag. 225
DOPPLER SIDEBORD	pag. 222
MILLE CONSOLE	pag. 220
MUFFIN LAMP	pag. 225
NEMESI / NEMESI LIGHT	pag. 224
ORIGAMI CONSOLE	pag. 221
RAIN	pag. 226
SHADE	pag. 222
THEDUCK	pag. 224

TECHNICAL INDEX

<u>DIVANI / SOFAS / SOFAS / CANAPÉS</u>	<u>pag. 228-233</u>
COLORS	pag. 228-229
LOVY	pag. 232
SKID	pag. 230-231
<u>POLTRONE / ARMCHAIRS / SESSEL / FAUTEUILS</u>	<u>pag. 234-237</u>
ALFIE ARM	pag. 234
ARNO	pag. 234
BODO	pag. 235
BRUNO	pag. 235
EDDY	pag. 236
LOCK	pag. 236
<u>LETTI E COMPLEMENTI LETTO / ACCESSORIES AND BED ACCESSORIES BETTEN UND EINRICHTUNGSGEGENSTÄNDE / LITS ET ACCESSOIRES</u>	<u>pag. 238-240</u>
BLANKET	pag. 238
GALA	pag. 239
WAI	pag. 240

BIG TABLE FISSO / FIXED / FEST / FIXE

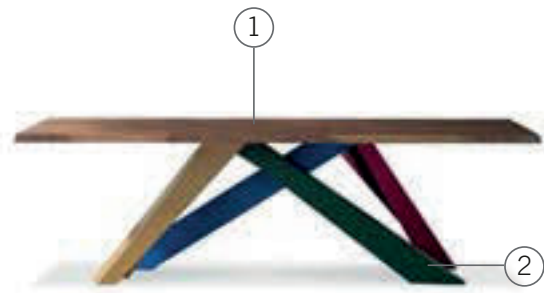

①

FINITURA PIANO / TOP FINISH / PLATTE AUSFÜHRUNG / FINITION PLAN

CERAMICA OPACA



1. grigio Ardesia

②

FINITURA GAMBE / LEGS FINISH / BEINE AUSFÜHRUNG / FINITION PIEDS

VERNICIATO OPACO

1. COMBINAZIONE 3
brass yellow/royal blue/racing green/bordeaux

200

MAT CERAMIC

1. Ardesia grey

MATT KERAMIC

1. Ardesia Grau

CÉRAMIQUE OPAQUE

1. gris Ardesia

MAT PAINTED

1. COMBINAZIONE 3
brass yellow/royal blue/racing green/bordeaux

LACKIERT MATT

1. KOMBINATION 3
brass yellow/royal blue/racing green/bordeaux

VERNI OPAQUE

1. COMBINAISON 3
brass yellow/royal blue/racing green/bordeaux

DIMENSIONI / DIMENSIONS / GRÖßEN / DIMENSIONS

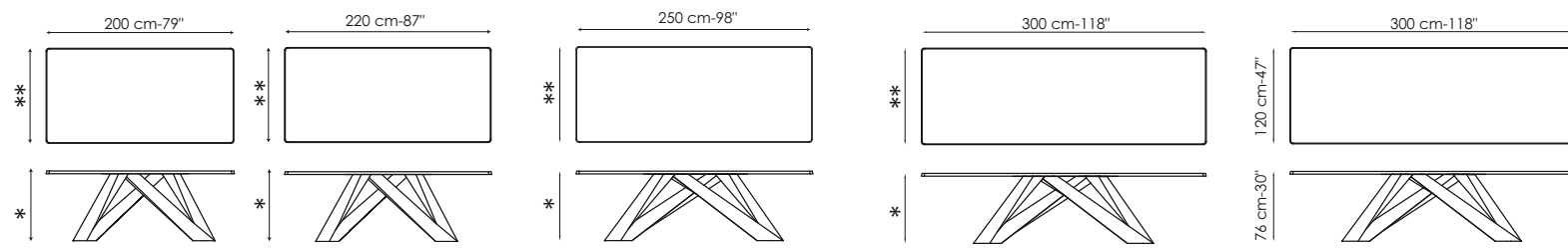

** 100 cm – 39.4"
legno, ceramica / wood, ceramic / Holz, Keramik / bois, céramique
99 cm – 39"
cristallo / glass / Glas / cristal

* 74,50 cm – 29.3"
laccato, impiallacciato / lacquered, veneered / lackiert, furniert / laqué, plaqué
76 cm – 29.9"
massello, legno con bordi naturali / solid, wood with natural edges / Massivholz, Holz mit Waldkante / massif, bois avec contour naturel

74 cm – 29.2"
cristallo, ceramica / glass, ceramic / Glas, Keramik / cristal, céramique

** 100 cm – 39.4"
massello, impiallacciato, laccato, cristallo, ceramica / solid, veneered, lacquered, glass, ceramic / Massivholz, furniert, lackiert, Glas, Keramik / massif, plaqué, laqué, cristal, céramique

110 cm – 43.3"
legno con bordi naturali / wood with natural edges / Holz mit Waldkante / bois avec contour naturel

* 74,50 cm – 29.3"
laccato, impiallacciato / lacquered, veneered / lackiert, furniert / laqué, plaqué

76 cm – 29.9"
massello, legno con bordi naturali / solid, wood with natural edges / Massivholz, Holz mit Waldkante / massif, bois avec contour naturel

74 cm – 29.2"
cristallo, ceramica / glass, ceramic / Glas, Keramik / cristal, céramique

** 108 cm – 42.5"
massello, impiallacciato, laccato, cristallo, ceramica lucida / solid, veneered, lacquered, glass, glossy ceramic / Massivholz, furniert, lackiert, Glas, glanzend Keramik / massif, plaqué, laqué, cristal, céramique brillante

100 cm – 39.4"
ceramica opaca / matt ceramic / céramique opaque

* 74,50 cm – 29.3"
laccato, impiallacciato / lacquered, veneered / lackiert, furniert / laqué, plaqué

76 cm – 29.9"
massello / solid / Massivholz / massif

74 cm – 29.2"
cristallo, ceramica / glass, ceramic / Glas, Keramik / cristal, céramique

300x120 cm – 118x47"
massello, legno con bordi naturali / solid wood, wood with natural edges / Massivholz, Holz mit Waldkante / bois massif, bois avec contour naturel

BIG TABLE ALLUNGABILE / EXTENDABLE / AUSZIEHBAR / EXTENSIBLE

①

FINITURA PIANO / TOP FINISH / PLATTE AUSFÜHRUNG / FINITION PLAN

CERAMICA OPACA

solo per 200 cm



1. grigio Ardesia

②

FINITURA GAMBE / LEGS FINISH / BEINE AUSFÜHRUNG / FINITION PIEDS

VERNICIATO OPACO

1. COMBINAZIONE 3
brass yellow/royal blue/racing green/bordeaux

201

MAT CERAMIC

only for 200 cm
1. Ardesia grey

MATT KERAMIC

nur für 200 cm
1. Ardesia Grau

CÉRAMIQUE OPAQUE

seulement 200 cm
1. gris Ardesia

MAT PAINTED

1. COMBINAZIONE 3
brass yellow/royal blue/racing green/bordeaux

LACKIERT MATT

1. KOMBINATION 3
brass yellow/royal blue/racing green/bordeaux

VERNI OPAQUE

1. COMBINAISON 3
brass yellow/royal blue/racing green/bordeaux

DIMENSIONI / DIMENSIONS / GRÖßEN / DIMENSIONS

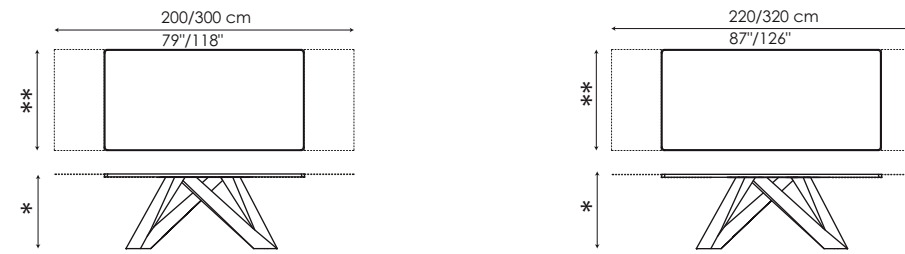

** 100 cm – 39.4"
legno, ceramica / wood, ceramic / Holz, Keramik / bois, céramique
99 cm – 39"
cristallo / glass / Glas / cristal

* 75 cm – 29.5"
legno / wood / Holz / bois

74,50 cm – 29.3"
cristallo, ceramica / glass, ceramic / Glas, Keramik / cristal, céramique

** 100 cm – 39.4"
legno / wood / Holz / bois
99 cm – 39"
cristallo / glass / Glas / cristal

* 75 cm – 29.5"
legno / wood / Holz / bois

74,50 cm – 29.3"
cristallo / glass / Glas / cristal

* prolunga disponibile anche in cristallo
* extension also available in glass
* Verlängerung verfügbar auch auf Glas
* rallonge disponible aussi en cristal

COP

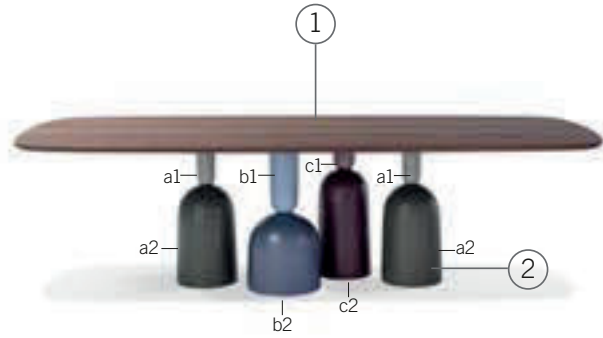

①

FINITURA PIANO / TOP FINISH / PLATTE AUSFÜHRUNG / FINITION PLAN

LACCATO OPACO



1. bianco opaco

MPIALLACCIATO LEGNO



2. noce Canaletto

CRISTALLO



3. acidato nero



4. extrachiaro acidato bianco

CERAMICA OPACA

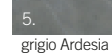

5. grigio Ardesia

CERAMICA LUCIDA



6. Calacatta

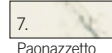

7. Paonazzetto

②

FINITURA GAMBE / LEGS FINISH / BEINE AUSFÜHRUNG / FINITION PIEDS

METALLO VERNICIATO OPACO

1. COMBINAZIONE 1
a1.tortora b1.lilac c1.orchid
a2.marrone b2.plum c2.raspberry

2. bianco



3. grigio antracite



4. tortora



5. nero



6. bordeaux



7. racing green



8. coffee brown

METALLO FINITURA

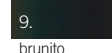

9. brunito

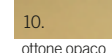

10. ottone opaco

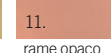

11. rame opaco

PAINTED MAT METAL

1. COMBINAZIONE 1
a1.dove grey - a2.brown
b1.lilac - b2.plum
c1.orchid - c2.raspberry

2. white

3. anthracite grey

4. dove grey

5. black

6. bordeaux

7. racing green

8. coffee brown

MATT LACKIERT METALL

1. KOMBINATION 1
a1.Taubengrau - a2.Braun
b1.Lilac - b2.Plum
c1.Orchid - c2.Raspberry

2. Weiss

3. Anthrazitgrau

4. Taubengrau

5. Schwarz

6. Bordeaux

7. Racing green

8. Coffee brown

MÉTAL VERNI OPAQUE

1. COMBINAZIONE 3
a1.gris tourterelle - a2.marron
b1.lilac - b2.plum
c1.orchid - c2.raspberry

2. blanc

3. gris anthracite

4. gris tourterelle

5. noir

6. bordeaux

7. racing green

8. coffee brown

METALL AUSFÜHRUNG

9. Brüniert

10. Messing matt

11. Kupfer matt

FINITION MÉTAL

9. bruni

10. laiton opaque

11. cuivre opaque

MILLE

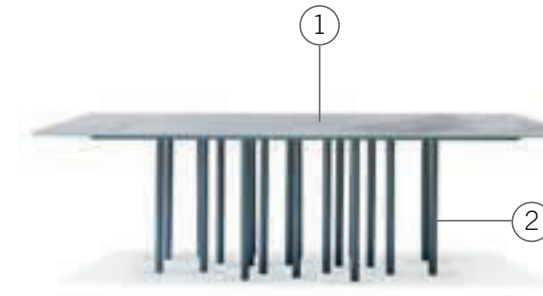

①

FINITURA PIANO / TOP FINISH / PLATTE AUSFÜHRUNG / FINITION PLAN

CRISTALLO



1. acidato nero

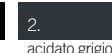

2. acidato grigio antracite



3. extrachiaro acidato bianco

CERAMICA LUCIDA

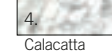

4. Calacatta

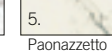

5. Paonazzetto

CERAMICA OPACA

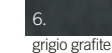

6. grigio grafite

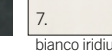

7. bianco iridium



8. grigio Ardesia

GLASS

1. acid-treated black
2. acid-treated anthracite
3. extra-light acid treated white

GLOSSY CERAMIC

4. Calacatta
5. Paonazzetto

MATT CERAMIC

6. graphite grey
7. iridium white
8. Ardesia grey

GLAS

1. Geätztes Schwarz
2. Geätztes Anthrazitgrau
3. Geätztes extra-hell Weiss

GLÄNZEND KERAMIK

4. Calacatta
5. Paonazzetto

MATT KERAMIK

6. Graphitgrau
7. Iridium Weiss
8. Ardesia Grau

CRISTAL

1. traité à l'acide noir
2. traité à l'acide gris anthracite
3. extra-clair traité à l'acide blanc

CÉRAMIQUE BRILLANT

4. Calacatta
5. Paonazzetto

CÉRAMIQUE OPAQUE

6. gris graphite
7. blanc iridium
8. gris Ardesia

②

FINITURA GAMBE / LEGS FINISH / BEINE AUSFÜHRUNG / FINITION PIEDS

VERNICIATO OPACO



1. grigio antracite



2. bianco



3. bordeaux



4. tortora



5. marrone

METALLO



6. cromato

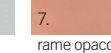

7. rame opaco

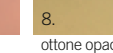

8. ottone opaco

MAT PAINTED

1. anthracite grey
2. white
3. bordeaux
4. dove grey
5. brown

METAL FINISH

6. chrome
7. mat copper
8. mat brass

LACKIERT MATT

1. Anthrazitgrau
2. Weiss
3. Bordeaux
4. Taubengrau
5. Braun

METALL AUSFÜHRUNG

6. Verchromt
7. Kupfer matt
8. Messing matt

VERNI OPAQUE

1. gris anthracite
2. blanc
3. bordeaux
4. gris tourterelle
5. marron

FINITION MÉTAL

6. chromé
7. cuivre opaque
8. laiton opaque

DIMENSIONI / DIMENSIONS / GRÖßEN / DIMENSIONS

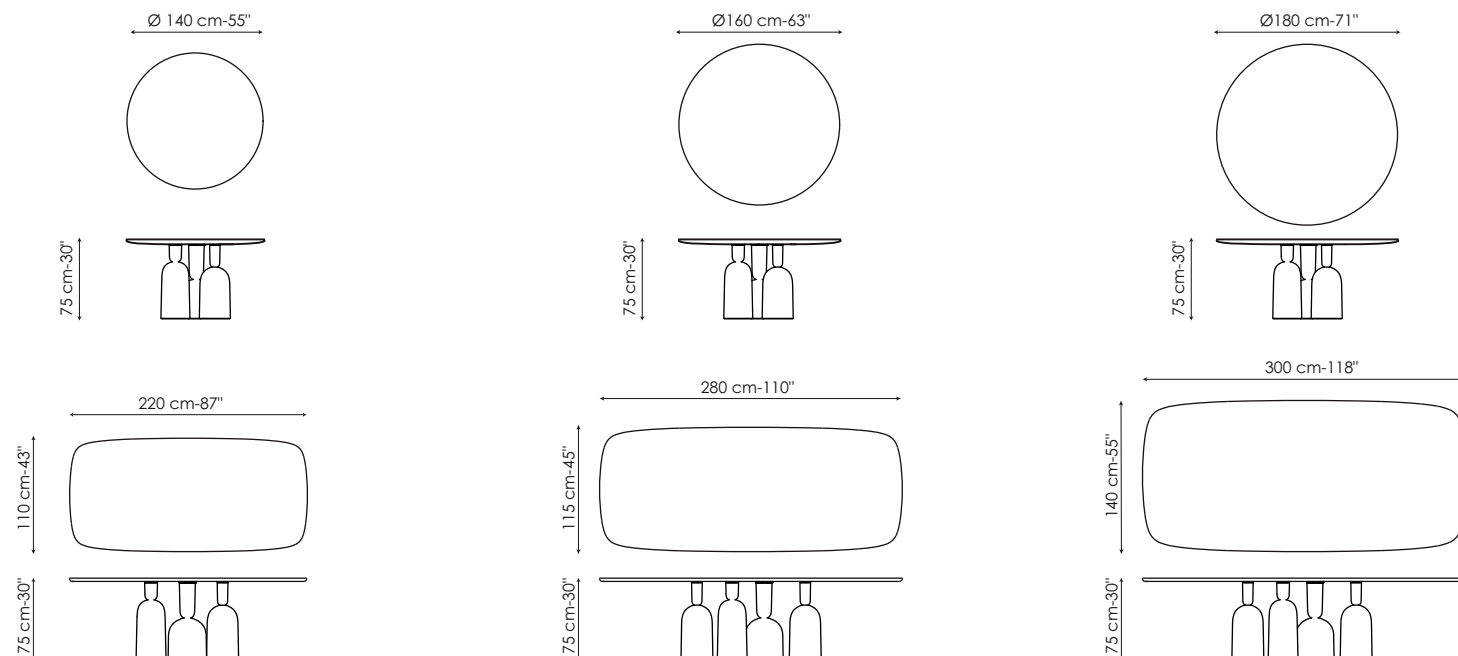

DIMENSIONI / DIMENSIONS / GRÖßEN / DIMENSIONS

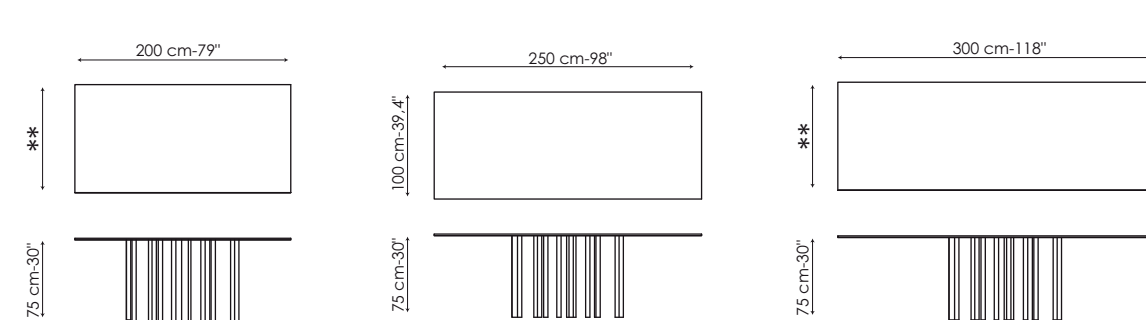

** 99 cm - 39.4"
cristallo / glass / Glas / cristal
100 cm - 39.4"
ceramica / ceramic / Keramik / céramique

** 100 cm - 39.4"
cristallo / glass / Glas / cristal
108 cm - 42.5"
ceramica / ceramic / Keramik / céramique

ORIGAMI FISSO / FIXED / FEST / FIXE



①

FINITURA PIANO / TOP FINISH / PLATTE AUSFÜHRUNG / FINITION PLAN

LACCATO OPACO



1. bianco opaco

IMPIALLACCIATO LEGNO

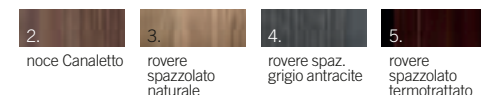
2. noce Canaletto
3. rovere spazzolato naturale
4. rovere spaz. grigio antracite
5. rovere spazzolato termotrattato

LEGNO MASSICCIO

6. noce americano
7. rovere spazzolato naturale

LEGNO CON BORDI NATURALI

8. rovere spaz. grigio antracite
9. noce americano

CRISTALLO

10. acidato nero
11. extrachiaro acidato bianco

CERAMICA LUCIDA

13. Calacatta
14. Paonazzetto

CERAMICA OPACA

15. bianco iridium
16. grigio grafite
17. grigio Ardesia
12. acidato grigio antracite

②

FINITURA GAMBE / LEGS FINISH / BEINE AUSFÜHRUNG / FINITION PIEDS

VERNICIATO OPACO

1. grigio antracite
2. bianco
3. bordeaux
4. tortora
5. marrone

METALLO

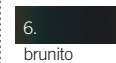

6. brunito

MAT PAINTED

1. anthracite grey
2. white
3. bordeaux
4. dove grey
5. brown

LACKIERT MATT

1. Anthrazitgrau
2. Weiss
3. Bordeaux
4. Taubengrau
5. Braun

VERNI OPAQUE

1. gris anthracite
2. blanc
3. bordeaux
4. gris tourterelle
5. marron

METAL FINISH

6. burnished

METALL AUSFÜHRUNG

6. Brüniert

FINITION MÉTAL

6. bruni

204

LACQUERED

1. mat white

VENEERED WOOD

2. walnut Canaletto
3. natural polished oak
4. anthracite grey polished oak
5. heat-treated polished oak

SOLID WOOD

6. American walnut
7. natural polished oak
8. anthracite grey polished oak

WOOD WITH NATURAL EDGES

9. American walnut

GLASS

10. acid-treated black
11. acid-treated anthracite
12. extra-light acid treated white

GLOSSY CERAMIC

13. Calacatta
14. Paonazzetto

MAT CERAMIC

15. graphite grey
16. iridium white
17. Ardesia grey

LACKIERT

1. Weiss matt

HOLZ FURNIERT

2. Nussbaum Canaletto
3. Eiche Natur poliert
4. Eiche Anthrazitgrau poliert
5. thermo-behandeltes poliertes Eiche

MASSIVHOLZ

6. Amerikaner Nussbaum
7. Eiche Natur poliert
8. Eiche Anthrazitgrau poliert

HOLZ MIT WALDKANTE

9. Amerikaner Nussbaum

GLAS

10. Geätztes Schwarz
11. Geätztes Anthrazitgrau
12. Geätztes extra-hell Weiss

GLÄNZEND KERAMIK

13. Calacatta
14. Paonazzetto

MATT KERAMIK

15. Graphitgrau
16. Iridium Weiss
17. Ardesia Grau

LAQUÉ

1. blanc opaque

BOIS PLAQUÉ

2. noyer Canaletto
3. rouvre brossé naturel
4. rouvre brossé gris anthracite
5. rouvre brossé traité thermiquement

BOIS MASSIF

6. noyer américain
7. rouvre brossé naturel
8. rouvre brossé gris anthracite

BOIS AVEC CONTOUR NATUREL

9. noyer américain

CRISTAL

10. traité à l'acide noir
11. traité à l'acide gris anthracite
12. extra-clair traité à l'acide blanc

CÉRAMIQUE BRILLANT

13. Calacatta
14. Paonazzetto

CÉRAMIQUE OPAQUE

15. gris graphite
16. blanc iridium
17. gris Ardesia

DIMENSIONI / DIMENSIONS / GRÖßEN / DIMENSIONS

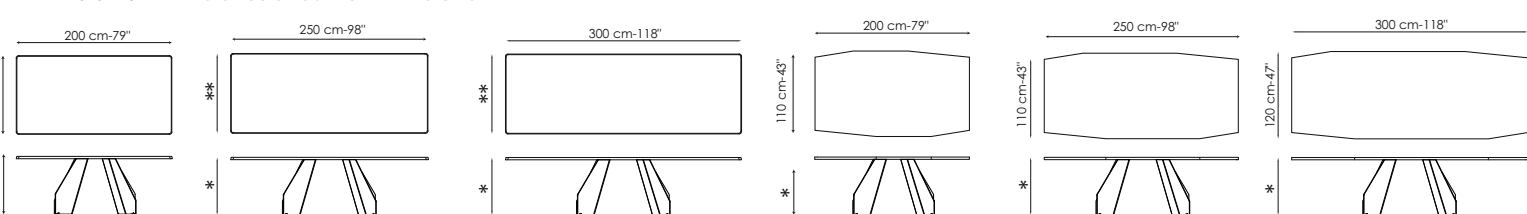

* 75 cm – 29,5"
legno laccato, impiallacciato, massiccio / lacquered, veneered, solid wood / Holz Lackiert, furniert, Massivholz / bois laqué, plaqué, massif
74 cm – 29,2"
cristallo, ceramica / glass, ceramic / Glas, Keramik / cristal, céramique

** 99 cm – 39"
cristallo / glass / Glas / cristal
100 cm – 39,4"
legno laccato, impiallacciato, massiccio, con bordi naturali, ceramica, cristallo / lacquered, veneered, solid, with natural edges wood, ceramic, glass / Holz lackiert, furniert, mit Waldkante, Massivholz, Keramik, Glas / bois laqué, plaqué, massif, avec contour naturel, céramique, cristal
110 cm – 43"
legno con bordi naturali / wood with natural edges / Holz mit Waldkante / bois avec contour naturel
108 cm – 42,5"
legno laccato, impiallacciato, massiccio, cristallo, ceramica Calacatta, Paonazzetto, grigio Ardesia / lacquered, veneered, solid, glass, Calacatta, Paonazzetto, Ardesia grey ceramic / Holz lackiert, furniert, Massivholz, Glas, Calacatta, Paonazzetto, Ardesia Grau Keramik / bois laqué, plaqué, massif, cristal, céramique Calacatta, Paonazzetto, gris Ardesia
120 cm – 47"
legno con bordi naturali / wood with natural edges / Holz mit Waldkante / bois avec contour naturel

OCTAGONAL

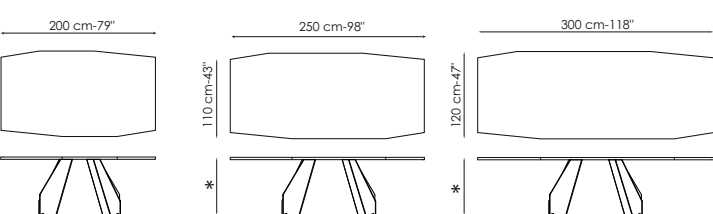

Versione Octagonale solo in ceramica Calacatta e Ceramica grigio Ardesia
Octagonal version available only in Calacatta ceramic and Ardesia grey ceramic
Achteckig Ausführung nur aus Calacatta Keramik und Ardesia Grau Keramik
Version Octogonale disponible seulement en céramique Calacatta et céramique gris Ardesia

* 75 cm – 29,5"
legno laccato, impiallacciato, massiccio / lacquered, veneered, solid wood / Holz Lackiert, furniert, Massivholz / bois laqué, plaqué, massif
74 cm – 29,2"
cristallo, ceramica / glass, ceramic / Glas, Keramik / cristal, céramique

ORIGAMI ALLUNGABILE / EXTENDABLE / AUSZIEHBAR / EXTENSIBLE

①

FINITURA PIANO / TOP FINISH / PLATTE AUSFÜHRUNG / FINITION PLAN

LACCATO

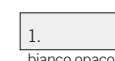

1. bianco opaco

IMPIALLACCIATO LEGNO

2. noce Canaletto
3. rovere spazzolato termotrattato

CRISTALLO

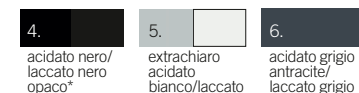
4. acidato nero/laccato nero opaco*
5. extrachiaro acidato bianco/laccato bianco opaco*
6. acidato grigio antracite/laccato grigio antracite*

CERAMICA LUCIDA



7. Calacatta

CERAMICA OPACA

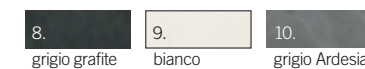
8. grigio grafite
9. bianco iridium
10. grigio Ardesia

LACQUERED

1. mat white

VENEERED WOOD

2. walnut Canaletto
3. heat-treated polished oak

GLASS

4. acid-treated black/lacquered mat black*
5. extra-light acid treated white/lacquered mat white*
6. acid-treated anthracite grey/lacquered anthracite grey*

GLOSSY CERAMIC

7. Calacatta

MAT CERAMIC

8. graphite grey
9. iridium white
10. Ardesia grey

LACKIERT

1. Weiss matt

HOLZ FURNIERT

2. Nussbaum Canaletto
3. thermo-behandeltes poliertes Eiche

GLAS

4. Geätztes Schwarz/Lackiert Schwarz mat*
5. Geätztes extra-hell Weiss/Lackiert Weiss mat*
6. Geätztes Anthrazitgrau/Lackiert Anthrazitgrau*

GLÄNZEND KERAMIK

7. Calacatta

MATT KERAMIK

8. Graphitgrau
9. Iridium Weiss
10. Ardesia Grau

LAQUÉ

1. blanc opaque

BOIS PLAQUÉ

2. noyer Canaletto
3. rouvre brossé traité thermiquement

CRISTAL

4. traité à l'acide noir/laqué noir opaque*
5. extra-clair traité à l'acide blanc/laqué blanc opaque*
6. traité à l'acide gris anthracite/laqué gris anthracite*

CÉRAMIQUE BRILLANT

7. Calacatta

CÉRAMIQUE OPAQUE

8. gris graphite
9. blanc iridium
10. gris Ardesia

②

FINITURA GAMBE / LEGS FINISH / BEINE AUSFÜHRUNG / FINITION PIEDS

VERNICIATO OPACO

1. grigio antracite
2. bianco
3. bordeaux
4. tortora
5. marrone

METALLO



6. brunito

MAT PAINTED

1. anthracite grey
2. white
3. bordeaux
4. dove grey
5. brown

LACKIERT MATT

1. Anthrazitgrau
2. Weiss
3. Bordeaux
4. Taubengrau
5. Braun

VERNI OPAQUE

1. gris anthracite
2. blanc
3. bordeaux
4. gris tourterelle
5. marron

METAL FINISH

6. burnished

METALL AUSFÜHRUNG

6. Brüniert

FINITION MÉTAL

6. bruni

DIMENSIONI / DIMENSIONS / GRÖßEN / DIMENSIONS

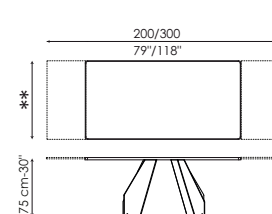

** 99 cm – 39"
legno laccato, legno impiallacciato, cristallo / lacquered wood, veneered wood, glass / Holz Lackiert, Holz furniert, Glas / bois laqué, bois plaqué, cristal
100 cm – 39,4"
ceramica / ceramic / Keramik / céramique

* prolunga disponibile anche in cristallo
* extension also available in glass
* Verlängerung verfügbar auch auf Glas
* rallonge disponible aussi en cristal



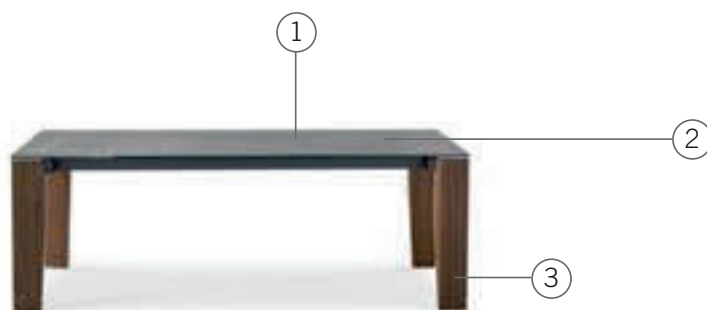

205

TRULY



①

FINITURA PIANO E PROLUNGHE / TOP AND EXTENSIONS FINISH / PLATTE UND VERLÄNGERUNGEN AUSFÜHRUNG / FINITION PLAN ET RALLONGES
CRISTALLO

1. 	2. 	3. 	4. 
extrachiaro verniciato bianco/ laccato bianco opaco	acidato nero/ laccato nero opaco	extrachiaro acidato bianco/laccato bianco opaco	acidato grigio antracite/ laccato grigio antracite opaco

CERAMICA LUCIDA

5. 
Calacatta/ laccato bianco opaco

CERAMICA OPACA

6. 
grigio Ardesia/ laccato grigio antracite opaco

GLASS

- extra-light painted white/
lacquered mat white
- acid treated black/lacquered
mat black
- extra-light acid treated
white/lacquered mat white
- acid treated anthracite grey/
lacquered mat anthracite grey

GLAS

- extra-hell Weiss lackiert/
Lackiert Weiss mat
- Geätztes Schwarz/Lackiert
Weiss mat
- Geätztes extra-hell Weiss/
Lackiert Weiss mat
- Geätztes Anthrazitgrau/
Lackiert Anthrazitgrau mat

CRISTAL

- extra-clair verni blanc/laqué
blanc opaque
- traité à l'acide noir/laqué
noir opaque
- extra-clair traité à l'acide
blanc/laqué blanc opaque
- traité à l'acide gris anthracite/
laqué gris anthracite opaque

GLOSSY CERAMIC

- Calacatta/lacquered mat
white

GLÄNZEND KERAMIK

- Calacatta/Lackiert Weiss
mat

CÉRAMIQUE BRILLANT

- Calacatta/laqué blanc
opaque

MAT CERAMIC

- Ardesia grey/lacquered mat
anthracite grey

MATT KERAMIK

- Ardesia Grau/Lackiert
Anthrazitgrau mat

CÉRAMIQUE OPAQUE

- gris Ardesia/laqué gris
anthracite opaque

③

FINITURA GAMBE / LEGS FINISH / BEINE AUSFÜHRUNG / FINITION PIEDS
LEGNO MASSELLO

1. 	2. 	3. 
rovere spazzolato naturale	rovere spaz. grigio antracite	noce americano

SOLID WOOD

- natural polished oak
- anthracite grey polished oak
- American walnut

MASSIVHOLZ



- Eiche Natur poliert
- Eiche Anthrazitgrau poliert
- Amerikaner Nussbaum

BOIS MASSIF

- rovere brossé naturel
- rovere brossé gris anthracite
- noyer américain

②

FINITURA STRUTTURA / FRAME FINISH / STRUKTUR AUSFÜHRUNG / FINITION STRUCTURE
METALLO VERNICIATO OPACO

1. 	2. 	3. 
bianco	grigio antracite	nero

MAT PAINTED

- white
- anthracite grey
- black

LACKIERT MATT

- Weiss
- Anthrazitgrau
- Schwarz

VERNI OPAQUE

- blanc
- gris anthracite
- noir

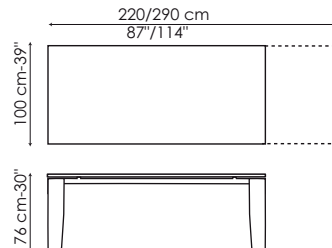
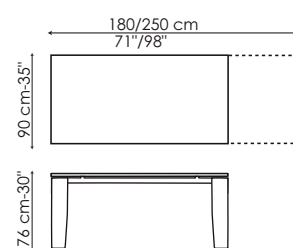
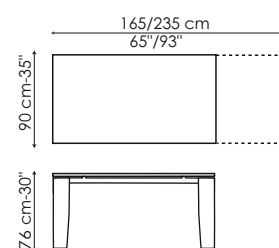
DIMENSIONI / DIMENSIONS / GRÖßEN / DIMENSIONS

BIG TABLE FISSO / FIXED / FEST / FIXE

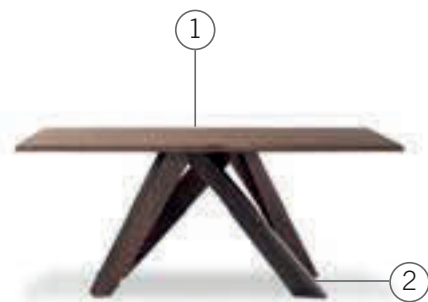

①

FINITURA PIANO / TOP FINISH / PLATTE AUSFÜHRUNG / FINITION PLAN

LACCATO OPACO

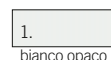

1. bianco opaco

LEGNO MASSELLO



2. noce americano

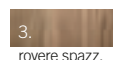

3. rovere spazz. termotrattato



4. rovere spaz. grigio antracite

IMPIALLACCIATO LEGNO



5. noce canaletto



6. rovere spazz. termotrattato

CRISTALLO



7. acidato grigio antracite



8. extrachiaro acidato bianco

CERAMICA LUCIDA



9. Calacatta

CERAMICA OPACA

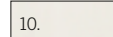

10. bianco iridium

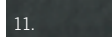

11. grigio grafite



12. grigio Ardesia

②

FINITURA GAMBE / LEGS FINISH / BEINE AUSFÜHRUNG / FINITION PIEDS

VERNICIATO OPACO



1. grigio antracite

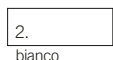

2. bianco



3. bordeaux



4. tortora



5. marrone

COMBINAZIONE 1

rosso corallo/arancio/verde/lilla

COMBINAZIONE 2

rosa cipria/marrone/tortora/amaranto

COMBINAZIONE 3

brass yellow/royal blue/racing green/bordeaux

METALLO FINITURA



9. acciaio Corten



10. bronzo rame

LACQUERED

1. mat white

SOLID WOOD

2. American walnut
3. natural polished oak
4. anthracite grey polished oak

VENEERED WOOD

5. walnut Canaletto
6. heat-treated polished oak

GLASS

7. acid-treated anthracite
8. extra-light acid treated white

GLOSSY CERAMIC

9. Calacatta

MAT CERAMIC

10. graphite grey
11. iridium white
12. Ardesia grey

LACKIERT

1. Weiss matt

MASSIVHOLZ

2. Amerikaner Nussbaum
3. Eiche Natur poliert
4. Eiche Anthrazitgrau poliert

HOLZ FURNIERT

5. Nussbaum Canaletto
6. thermo-behandelten poliert Eiche

GLAS

7. Geätztes Anthrazitgrau
8. Geätztes extra-hell Weiss

GLÄNZEND KERAMIK

9. Calacatta

MATT KERAMIK

10. Graphitgrau
11. Iridium Weiss
12. Ardesia Grau

LAQUÉ

1. blanc opaque

BOIS MASSIF

2. noyer américain
3. rouvre brossé naturel
4. rouvre brossé gris anthracite

BOIS PLAQUÉ

5. noyer Canaletto
6. rouvre brossé traité thermiquement

CRISTAL

7. traité à l'acide gris anthracite
8. extra-clair traité à l'acide blanc

CÉRAMIQUE BRILLANT

9. Calacatta

CÉRAMIQUE OPAQUE

10. gris graphite
11. blanc iridium
12. gris Ardesia

MAT PAINTED

1. anthracite grey
2. white
3. bordeaux
4. dove grey
5. brown
6. COMBINATION 1 coral red/orange/green/lilac

7. COMBINATION 2 powder pink/brown/dove grey/amaranth

8. COMBINATION 3 brass yellow/royal blue/racing green/bordeaux

METAL FINISH

9. Corten steel
10. copper bronze

LACKIERT MATT

1. Anthrazitgrau
2. Weiss
3. Bordeaux
4. Taubengrau
5. Braun
6. KOMBINATION 1 Korallenrot/Orange/Grün/Lila

7. KOMBINATION 2 Puderosa/Braun/Taubengrau/Amarant

8. KOMBINATION 3 brass yellow/royal blue/racing green/bordeaux

METALL AUSFÜHRUNG

9. Corten Stahl
10. Kupferbronze

VERNI OPAQUE

1. gris anthracite
2. blanc
3. bordeaux
4. gris tourterelle
5. marron
6. COMBINAISON 1 rouge corail/orange/vert/lilas

7. COMBINAISON 2 rose poudré/marron/gris tourterelle/amarante

8. COMBINAISON 3 brass yellow/royal blue/racing green/bordeaux

METAL FINITION

9. acier corten
10. bronze cuivre

DIMENSIONI / DIMENSIONS / GRÖßEN / DIMENSIONS

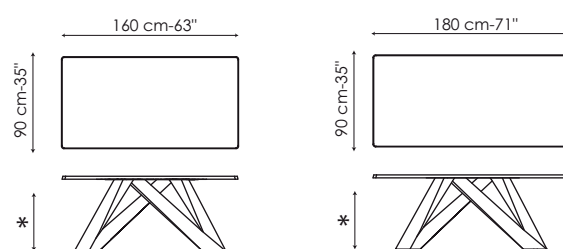

BIG TABLE ALLUNGABILE / EXTENDABLE / AUSZIEHBAR / EXTENSIBLE

①

FINITURA PIANO E PROLUNGHE / TOP AND EXTENSIONS FINISH / PLATTE UND VERLÄNGERUNGEN AUSFÜHRUNG / FINITION PLAN ET RALLONGES

LACCATO OPACO

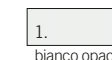

1. bianco opaco

IMPIALLACCIATO LEGNO



2. noce canaletto



3. rovere spazz. termotrattato

CRISTALLO

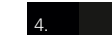

4. acidato nero/laccato nero opaco*

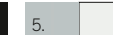

5. extrachiaro acidato bianco/laccato bianco opaco*



6. acidato grigio antracite/laccato grigio antracite opaco*

CERAMICA LUCIDA



7. Calacatta

CERAMICA OPACA

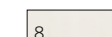

8. bianco iridium

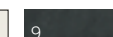

9. grigio grafite

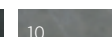

10. grigio Ardesia

②

FINITURA GAMBE / LEGS FINISH / BEINE AUSFÜHRUNG / FINITION PIEDS

VERNICIATO OPACO



1. grigio antracite

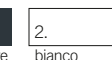

2. bianco



3. bordeaux



4. tortora



5. marrone

COMBINAZIONE 1

rosso corallo/arancio/verde/lilla

COMBINAZIONE 2

rosa cipria/marrone/tortora/amaranto

COMBINAZIONE 3

brass yellow/royal blue/racing green/bordeaux

METALLO FINITURA

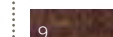

9. acciaio Corten

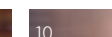

10. bronzo rame

①

FINITURA PIANO E PROLUNGHE / TOP AND EXTENSIONS FINISH / PLATTE UND VERLÄNGERUNGEN AUSFÜHRUNG / FINITION PLAN ET RALLONGES

LACCATO OPACO

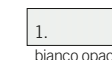

1. bianco opaco

IMPIALLACCIATO LEGNO



2. noce canaletto



3. rovere spazz. termotrattato

CRISTALLO

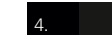

4. acidato nero/laccato nero opaco*

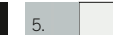

5. extrachiaro acidato bianco/laccato bianco opaco*



6. acidato grigio antracite/laccato grigio antracite opaco*

CERAMICA LUCIDA



7. Calacatta

CERAMICA OPACA

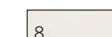

8. bianco iridium

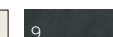

9. grigio grafite

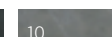

10. grigio Ardesia

②

FINITURA GAMBE / LEGS FINISH / BEINE AUSFÜHRUNG / FINITION PIEDS

VERNICIATO OPACO



1. grigio antracite



2. bianco



3. bordeaux



4. tortora



5. marrone

COMBINAZIONE 1

rosso corallo/arancio/verde/lilla

COMBINAZIONE 2

rosa cipria/marrone/tortora/amaranto

COMBINAZIONE 3

brass yellow/royal blue/racing green/bordeaux

METALLO FINITURA



9. acciaio Corten

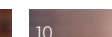

10. bronzo rame

MAT LACQUERED

1. white

VENEERED WOOD

2. walnut canaletto
3. heat-treated polished oak

GLASS

4. acid-treated black/lacquered mat black*
5. extra-light acid treated white/lacquered mat white*
6. acid-treated anthracite grey/lacquered mat anthracite grey*

GLOSSY CERAMIC

7. Calacatta

MAT CERAMIC

8. white iridium
9. graphite grey
10. Ardesia grey

LACKIERT

1. Weiss matt

HOLZ FURNIERT

2. Nussbaum Canaletto
3. thermo-behandelten poliertes Eiche

GLAS

4. Geätztes Schwarz/Lackiert Schwarz matt*
5. Geätztes extra-hell Weiss/Lackiert Weiss matt*
6. Geätztes Anthrazitgrau/Lackiert Anthrazitgrau*

GLÄNZEND KERAMIK

7. Calacatta

MATT KERAMIK

8. Graphitgrau
9. Iridium Weiss
10. Ardesia Grau

LAQUÉ

1. blanc opaque

BOIS PLAQUÉ

2. noyer Canaletto
3. rouvre brossé traité thermiquement

CRISTAL

4. traité à l'acide noir/laqué noir opaque*
5. extra-clair traité à l'acide blanc/laqué blanc opaque*
6. traité à l'acide gris anthracite/laqué gris anthracite*

CÉRAMIQUE BRILLANT

7. Calacatta

CÉRAMIQUE OPAQUE

8. gris graphite
9. blanc iridium
10. gris Ardesia

MAT PAINTED

1. anthracite grey
2. white
3. bordeaux
4. dove grey
5. brown
6. COMBINATION 1 coral red/orange/green/lilac

7. COMBINATION 2 powder pink/brown/dove grey/amaranth

8. COMBINATION 3 brass yellow/royal blue/racing green/bordeaux

METAL FINISH

9. Corten steel
10. copper bronze

LACKIERT MATT

1. Anthrazitgrau
2. Weiss
3. Bordeaux
4. Taubengrau
5. Braun
6. KOMBINATION 1 Korallenrot/Orange/Grün/Lila

7. KOMBINATION 2 Puderosa/Braun/Taubengrau/Amarant

8. KOMBINATION 3 brass yellow/royal blue/racing green/bordeaux

METALL AUSFÜHRUNG

9. Corten Stahl
10. Kupferbronze

VERNI OPAQUE

1. gris anthracite
2. blanc
3. bordeaux
4. gris tourterelle
5. marron
6. COMBINAISON 1 rouge corail/orange/vert/lilas

7. COMBINAISON 2 rose poudré/marron/gris tourterelle/amarante

8. COMBINAISON 3 brass yellow/royal blue/racing green/bordeaux

METAL FINITION

9. acier corten
10. bronze cuivre

DIMENSIONI / DIMENSIONS / GRÖßEN / DIMENSIONS

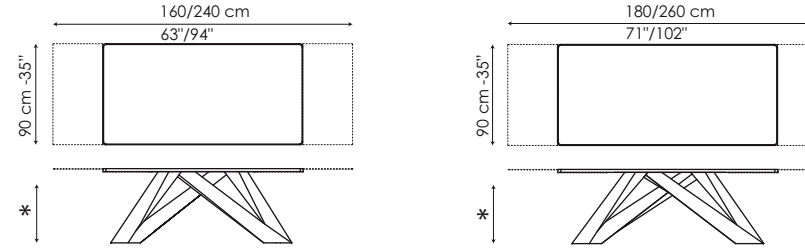

* 74 cm – 29.2"
legno laccato, legno impiallacciato, ceramica, cristallo / lacquered wood, veneered wood, ceramic, glass / Holz Lackiert, Holz furniert, Keramik, Glas / bois laqué, bois plaqué, céramique, cristal
74.5 cm – 29.3"
legno massello / solid wood / Massivholz / bois massif

* 75 cm – 29.5"
legno laccato, legno impiallacciato, ceramica / lacquered wood, veneered wood, ceramic / Holz Lackiert, Holz furniert, Keramik / bois laqué, bois plaqué, céramique
74 cm – 29.2"
cristallo / glass / Glas / cristal

* prolunga disponibile anche in cristallo
* extension also available in glass
* Verlängerung verfügbar auch auf Glas
* rallonge disponible aussi en cristal

NOA FISSO / FIXED / FEST / FIXE

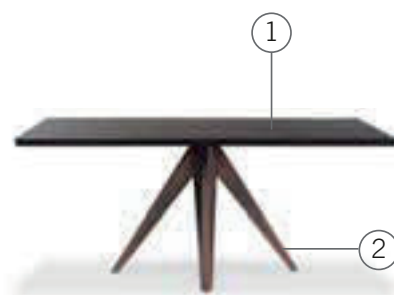

①

FINITURA PIANO / TOP FINISH / PLATTE AUSFÜHRUNG / FINITION PLAN

LACCATO

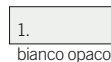

1. bianco opaco

IMPIALLACCIATO LEGNO



2. noce Canaletto



3. rovere spazzolato termotrattato

LEGNO MASSICCIO



4. noce americano

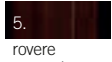

5. rovere spazzolato naturale

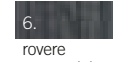

6. rovere spaz. grigio antracite

CRISTALLO



7. acidato grigio antracite

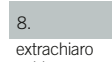

8. extrachiaro acidato bianco

CERAMICA LUCIDA



9. Calacatta

CERAMICA OPACA



10. grigio grafite

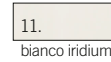

11. bianco iridium



12. grigio Ardesia

②

FINITURA GAMBE / LEGS FINISH / BEINE AUSFÜHRUNG / FINITION PIEDS

VERNICIATO OPACO



1. grigio antracite

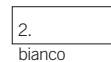

2. bianco



3. bordeaux



4. tortora



5. marrone

METALLO

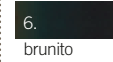

6. brunito

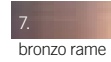

7. bronzo rame

NOA ALLUNGABILE / EXTENDABLE / AUSZIEHBAR / EXTENSIBLE

①

FINITURA PIANO E PROLUNGHE / TOP AND EXTENSIONS FINISH / PLATTE UND VERLÄNGERUNGEN AUSFÜHRUNG / FINITION PLAN ET RALLONGES

LACCATO

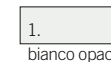

1. bianco opaco

IMPIALLACCIATO LEGNO



2. noce Canaletto



3. rovere spazzolato termotrattato

CRISTALLO



4. acidato nero/laccato nero opaco*

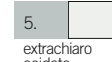

5. extrachiaro acidato bianco/laccato bianco opaco*



6. acidato grigio antracite/laccato grigio antracite*

CERAMICA LUCIDA



7. Calacatta

CERAMICA OPACA

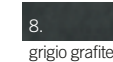

8. grigio grafite



9. bianco iridium



10. grigio Ardesia

②

FINITURA GAMBE / LEGS FINISH / BEINE AUSFÜHRUNG / FINITION PIEDS

VERNICIATO OPACO



1. grigio antracite

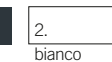

2. bianco



3. bordeaux



4. tortora



5. marrone

METALLO

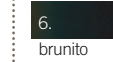

6. brunito

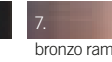

7. bronzo rame

LACQUERED

1. mat white

VENEERED WOOD

2. walnut Canaletto
3. heat-treated polished oak

SOLID WOOD

4. American walnut
5. natural polished oak
6. anthracite grey polished oak

GLASS

7. acid-treated anthracite
8. extra-light acid treated white

GLOSSY CERAMIC

9. Calacatta

MAT CERAMIC

10. graphite grey
11. iridium white
12. Ardesia grey

AUSFÜHRUNG LACKIERT

1. Weiss matt

HOLZ FURNIERT

2. Nussbaum Canaletto
3. thermo-behandeltes poliertes Eiche

MASSIVHOLZ

4. Amerikaner Nussbaum
5. Eiche Natur poliert
6. Eiche Anthrazitgrau poliert

GLAS

7. Geätztes Anthrazitgrau
8. Geätztes extra-hell Weiss

GLÄNZEND KERAMIK

9. Calacatta

MATT KERAMIK

10. Graphitgrau
11. Iridium Weiss
12. Ardesia Grau

LAQUÉ

1. blanc opaque

BOIS PLAQUÉ

2. noyer Canaletto
3. rouvre brossé traité thermiquement

BOIS MASSIF

4. noyer américain
5. rouvre brossé naturel
6. rouvre brossé gris anthracite

CRISTAL

7. traité à l'acide gris anthracite
8. extra-clair traité à l'acide blanc

CÉRAMIQUE BRILLANT

9. Calacatta

CÉRAMIQUE OPAQUE

10. gris graphite
11. blanc iridium
12. gris Ardesia

MAT PAINTED

1. anthracite grey
2. white
3. bordeaux
4. dove grey
5. brown

METAL FINISH

6. burnished
7. copper bronze

LACKIERT MATT

1. Anthrazitgrau
2. Weiss
3. Bordeaux
4. Taubengrau
5. Braun

METALL AUSFÜHRUNG

6. Brüniert
7. Kupferbronze

VERNIS OPAQUE

1. gris anthracite
2. blanc
3. bordeaux
4. gris tourterelle
5. marron

FINITION MÉTAL

6. bruni
7. bronze cuivre

MAT LACQUERED

1. white

VENEERED WOOD

2. walnut canaletto
3. heat-treated polished oak

GLASS

4. acid-treated black/lacquered mat black*
5. extra-light acid treated white/lacquered mat white*
6. acid-treated anthracite grey/lacquered mat anthracite grey*

GLOSSY CERAMIC

7. Calacatta

MAT CERAMIC

8. white iridium
9. graphite grey
10. Ardesia grey

LACKIERT

1. Weiss matt

HOLZ FURNIERT

2. Nussbaum Canaletto
3. thermo-behandelten poliertes Eiche

GLAS

4. Geätztes Schwarz/Lackiert Schwarz mat*
5. Geätztes extra-hell Weiss/Lackiert Weiss mat*
6. Geätztes Anthrazitgrau/Lackiert Anthrazitgrau*

GLÄNZEND KERAMIK

7. Calacatta

MATT KERAMIK

8. Graphitgrau
9. Iridium Weiss
10. Ardesia Grau

LAQUÉ

1. blanc opaque

BOIS PLAQUÉ

2. noyer Canaletto
3. rouvre brossé traité thermiquement

CRISTAL

4. traité à l'acide noir/laqué noir opaque*
5. extra-clair traité à l'acide blanc/laqué blanc opaque*
6. traité à l'acide gris anthracite/laqué gris anthracite*

CÉRAMIQUE BRILLANT

7. Calacatta

CÉRAMIQUE OPAQUE

8. gris graphite
9. blanc iridium
10. gris Ardesia

MAT PAINTED

1. anthracite grey
2. white
3. bordeaux
4. dove grey
5. brown

METAL FINISH

6. burnished
7. copper bronze

LACKIERT MATT

1. Anthrazitgrau
2. Weiss
3. Bordeaux
4. Taubengrau
5. Braun

METALL AUSFÜHRUNG

6. Brüniert
7. Kupferbronze

VERNIS OPAQUE

1. gris anthracite
2. blanc
3. bordeaux
4. gris tourterelle
5. marron

FINITION MÉTAL

6. bruni
7. bronze cuivre

DIMENSIONI / DIMENSIONS / GRÖßEN / DIMENSIONS

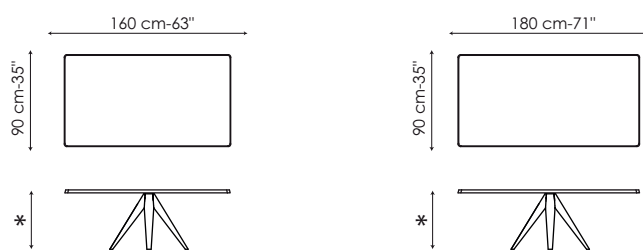

OVAL

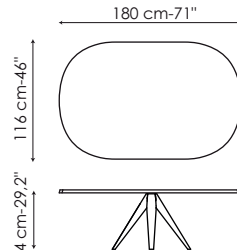

* 74 cm - 29,2"
legno laccato, legno impiallacciato, ceramica, cristallo / lacquered wood, veneered wood, ceramic, glass / Holz Lackiert, Holz furniert, Keramik, Glas / bois laqué, bois plaqué, céramique, cristal
74,5 cm - 29,3"
legno massiccio / solid wood / Massivholz / bois massif

Versione Oval solo in cristallo
Oval version available only in glass
Oval Ausführung nur aus Glas
Version Oval disponible seulement en cristal

DIMENSIONI / DIMENSIONS / GRÖßEN / DIMENSIONS

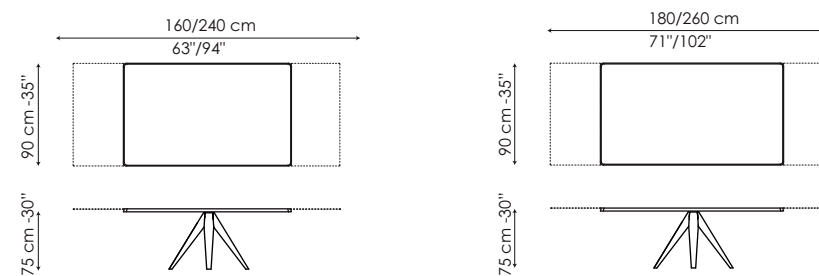

* prolunga disponibile anche in cristallo
* extension also available in glass
* Verlängerung verfügbar auch auf Glas
* rallonge disponible aussi en cristal

ORIGAMI FISSO / FIXED / FEST / FIXE

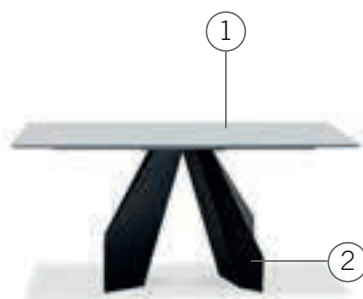

①

FINITURA PIANO / TOP FINISH / PLATTE AUSFÜHRUNG / FINITION PLAN

LACCATO OPACO



1. bianco opaco

IMPIALLACCIATO LEGNO



2. noce Canaletto

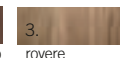

3. rovere spazzolato naturale



4. rovere spaz. grigio antracite

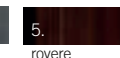

5. rovere spazzolato termotrattato

LEGNO MASSICCIO

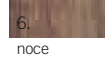

6. noce americano



7. rovere spazzolato naturale

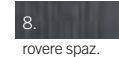

8. rovere spaz. grigio antracite

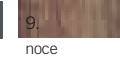

9. noce americano

CRISTALLO

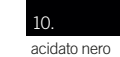

10. acidato nero



11. extrachiaro acidato bianco

CERAMICA LUCIDA



13. Calacatta

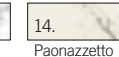

14. Paonazzetto

CERAMICA OPACA



15. bianco iridium

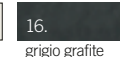

16. grigio grafite

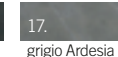

17. grigio Ardesia



12. acidato grigio antracite

②

FINITURA GAMBE / LEGS FINISH / BEINE AUSFÜHRUNG / FINITION PIEDS

VERNICIATO OPACO



1. grigio antracite



2. bianco



3. bordeaux



4. tortora



5. marrone

METALLO



6. brunito

MAT PAINTED

1. anthracite grey
2. white
3. bordeaux
4. dove grey
5. brown

METAL FINISH

6. burnished

LACKIERT MATT

1. Anthrazitgrau
2. Weiss
3. Bordeaux
4. Taubengrau
5. Braun

METALL AUSFÜHRUNG

6. Brüniert

VERNI OPAQUE

1. gris anthracite
2. blanc
3. bordeaux
4. gris tourterelle
5. marron

FINITION MÉTAL

6. bruni

ORIGAMI ALLUNGABILE / EXTENDABLE / AUSZIEHBAR / EXTENSIBLE

①

FINITURA PIANO E PROLUNGHE / TOP AND EXTENSIONS FINISH / PLATTE UND VERLÄNGERUNGEN AUSFÜHRUNG / FINITION PLAN ET RALLONGES

LACCATO

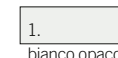

1. bianco opaco

IMPIALLACCIATO LEGNO



2. noce Canaletto



3. rovere spazzolato termotrattato

CRISTALLO



4. acidato nero/laccato nero opaco*

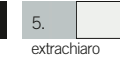

5. extrachiaro acidato bianco/laccato bianco opaco*

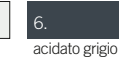

6. acidato grigio antracite/laccato grigio antracite*

CERAMICA LUCIDA



7. Calacatta

CERAMICA OPACA

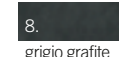

8. grigio grafite



9. bianco iridium

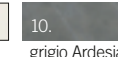

10. grigio Ardesia

MAT LACQUERED

1. white

VENEERED WOOD

2. walnut canaletto
3. heat-treated polished oak

GLASS

4. acid-treated black/lacquered mat black*
5. extra-light acid treated white/lacquered mat white*
6. acid-treated anthracite grey/lacquered mat anthracite grey*

GLOSSY CERAMIC

7. Calacatta

MAT CERAMIC

8. white iridium
9. graphite grey
10. Ardesia grey

LACKIERT

1. Weiss matt

HOLZ FURNIERT

2. Nussbaum Canaletto
3. thermo-behandelten poliertes Eiche

GLAS

4. Geätztes Schwarz/Lackiert Schwarz mat*
5. Geätztes extra-hell Weiss/Lackiert Weiss mat*
6. Geätztes Anthrazitgrau/Lackiert Anthrazitgrau*

GLÄNZEND KERAMIK

7. Calacatta

MATT KERAMIK

8. Graphitgrau
9. Iridium Weiss
10. Ardesia Grau

LAQUÉ

1. blanc opaque

BOIS PLAQUÉ

2. noyer Canaletto
3. rouvre brossé traité thermiquement

CRISTAL

4. traité à l'acide noir/laqué noir opaque*
5. extra-clair traité à l'acide blanc/laqué blanc opaque*
6. traité à l'acide gris anthracite/laqué gris anthracite*

CÉRAMIQUE BRILLANT

7. Calacatta

CÉRAMIQUE OPAQUE

8. gris graphite
9. blanc iridium
10. gris Ardesia

②

FINITURA GAMBE / LEGS FINISH / BEINE AUSFÜHRUNG / FINITION PIEDS

VERNICIATO OPACO



1. grigio antracite

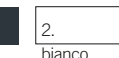

2. bianco



3. bordeaux



4. tortora



5. marrone

METALLO

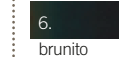

6. brunito

MAT PAINTED

1. anthracite grey
2. white
3. bordeaux
4. dove grey
5. brown

METAL FINISH

6. burnished

LACKIERT MATT

1. Anthrazitgrau
2. Weiss
3. Bordeaux
4. Taubengrau
5. Braun

METALL AUSFÜHRUNG

6. Brüniert

VERNI OPAQUE

1. gris anthracite
2. blanc
3. bordeaux
4. gris tourterelle
5. marron

FINITION MÉTAL

6. bruni

DIMENSIONI / DIMENSIONS / GRÖßEN / DIMENSIONS

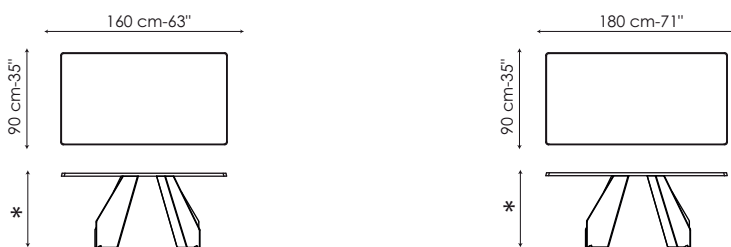

* 75 cm – 29,5"
legno laccato legno impiallacciato, legno massiccio / lacquered wood, veneered wood, solid wood / Holz Lackiert, Holz furniert, Massivholz / bois laqué, bois plaqué, bois massif
73,5 cm – 28,9"
cristallo / glass / Glas / cristal
74 cm – 29,2"
ceramica / ceramic / Keramik / céramique

DIMENSIONI / DIMENSIONS / GRÖßEN / DIMENSIONS

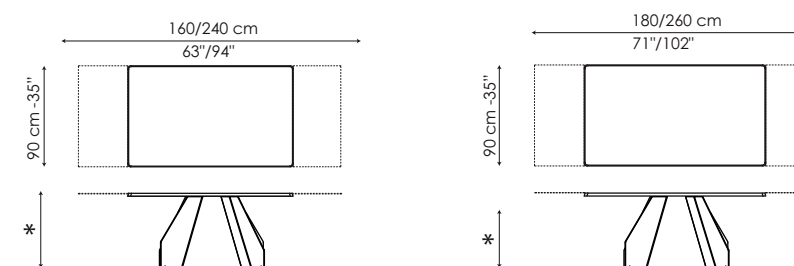

* 75,5 cm – 29,7"
legno laccato, legno impiallacciato, ceramica / lacquered wood, veneered wood, ceramic / Holz Lackiert, Holz furniert, Keramik / bois laqué, bois plaqué, céramique
75 cm – 29,5"
cristallo / glass / Glas / cristal

* prolunga disponibile anche in cristallo
* extension also available in glass
* Verlängerung verfügbar auch auf Glas
* rallonge disponible aussi en cristal

BAHIA



①
**FINITURA RIVESTIMENTO / UPHOLSTERY FINISH /
 BEZUG AUSFÜHRUNG / FINITION REVÊTEMENT**

RIVESTIMENTO

pelle
 ecopelle
 tessuto

UPHOLSTERY
 leather
 eco-leather
 fabric

BEZUG
 Leder
 Kunstleder
 Stoff

REVÊTEMENT
 cuir souple
 éco-cuir
 tissu

②

FINITURA GAMBE / LEGS FINISH / BEINE AUSFÜHRUNG / FINITION PIEDS

VERNICIATO OPACO



METALLO FINITURA



PAINTED MAT METAL

1. white
2. anthracite grey
3. dove grey
4. black
5. bordeaux
6. racing green
7. coffee brown

MATT LACKIERT METALL

1. Weiss
2. Anthrazitgrau
3. Taubengrau
4. Schwarz
5. Bordeaux
6. Racing green
7. Coffee brown

MÉTAL VERNI OPAQUE

1. blanc
2. gris anthracite
3. gris tourterelle
4. noir
5. bordeaux
6. racing green
7. coffee brown

METAL FINISH

8. chrome
9. black nickel
10. mat copper
11. mat brass

METALL AUSFÜHRUNG

8. Verchromt
9. Schwarz vernickelt
10. Kupfer matt
11. Messing matt

FINITION MÉTAL

8. chromé
9. noir nickel
10. cuivre opaque
11. laiton opaque

DIMENSIONI / DIMENSIONS / GRÖßEN / DIMENSIONS

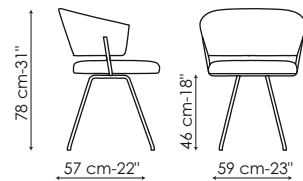

GILDA



①
**FINITURA RIVESTIMENTO / UPHOLSTERY FINISH /
 BEZUG AUSFÜHRUNG / FINITION REVÊTEMENT**

RIVESTIMENTO

pelle
 ecopelle

UPHOLSTERY
 leather
 eco-leather

BEZUG
 Leder
 Kunstleder

REVÊTEMENT
 cuir souple
 éco-cuir

DIMENSIONI / DIMENSIONS / GRÖßEN / DIMENSIONS

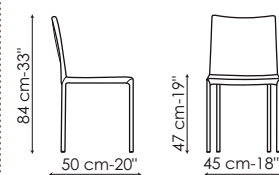

HERON, HERON UP



①
**FINITURA RIVESTIMENTO / UPHOLSTERY FINISH /
 BEZUG AUSFÜHRUNG / FINITION REVÊTEMENT**

RIVESTIMENTO

pelle
 ecopelle
 tessuto

UPHOLSTERY
 leather
 eco-leather
 fabric

BEZUG
 Leder
 Kunstleder
 Stoff

REVÊTEMENT
 cuir souple
 éco-cuir
 tissu

②

FINITURA GAMBE / LEGS FINISH / BEINE AUSFÜHRUNG / FINITION PIEDS

VERNICIATO OPACO



METALLO



RIVESTITE

pelle
 ecopelle
 tessuto

PAINTED MAT METAL

1. white
2. anthracite grey
3. dove grey
4. black
5. bordeaux
6. racing green
7. coffee brown

MATT LACKIERT METALL

1. Weiss
2. Anthrazitgrau
3. Taubengrau
4. Schwarz
5. Bordeaux
6. Racing green
7. Coffee brown

MÉTAL VERNI OPAQUE

1. blanc
2. gris anthracite
3. gris tourterelle
4. noir
5. bordeaux
6. racing green
7. coffee brown

METAL FINISH

8. chrome
9. black nickel
10. mat copper
11. mat brass

METALL AUSFÜHRUNG

8. Verchromt
9. Schwarz vernickelt
10. Kupfer matt
11. Messing matt

FINITION MÉTAL

8. chromé
9. noir nickel
10. cuivre opaque
11. laiton opaque

UPHOLSTERED

leather
 eco-leather
 fabric

BEZOGENE

Leder
 Kunstleder
 Stoff

REVÊTUES

cuir souple
 éco-cuir
 tissu

DIMENSIONI / DIMENSIONS / GRÖßEN / DIMENSIONS

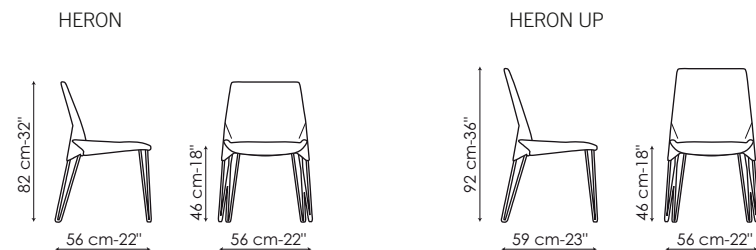

IDOLE



①
FINITURA / FINISH / AUSFÜHRUNG / FINITION

POLIPROPILENE OPACO



MAT POLYPROPYLENE

1. white
2. anthracite grey
3. dove grey

POLYPROPYLEN MATT

1. Weiss
2. Anthrazitgrau
3. Taubengrau

POLYPROPYLÈNE OPAQUE

1. blanc
2. gris anthracite
3. gris tourterelle

DIMENSIONI / DIMENSIONS / GRÖßEN / DIMENSIONS

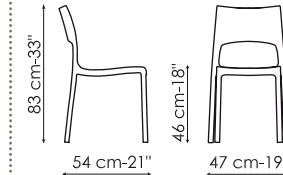

KETCH LOUNGE



①
FINITURA RIVESTIMENTO / UPHOLSTERY FINISH /
BEZUG AUSFÜHRUNG / FINITION REVÊTEMENT

RIVESTIMENTO

pelle
ecopelle
tessuto

UPHOLSTERY

leather
eco-leather
fabric

BEZUG

Leder
Kunstleder
Stoff

REVÊTEMENT

cuir souple
éco-cuir
tissu

DIMENSIONI / DIMENSIONS / GRÖßEN / DIMENSIONS

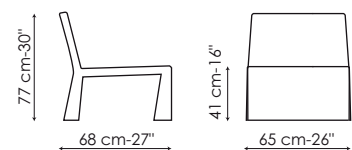

MISS KETCH

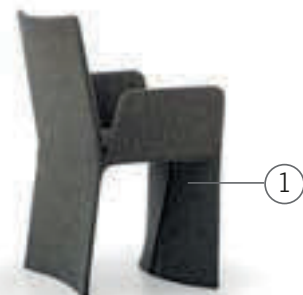

①
FINITURA RIVESTIMENTO / UPHOLSTERY FINISH /
BEZUG AUSFÜHRUNG / FINITION REVÊTEMENT

RIVESTIMENTO

pelle
ecopelle
tessuto

UPHOLSTERY

leather
eco-leather
fabric

BEZUG

Leder
Kunstleder
Stoff

REVÊTEMENT

cuir souple
éco-cuir
tissu

DIMENSIONI / DIMENSIONS / GRÖßEN / DIMENSIONS

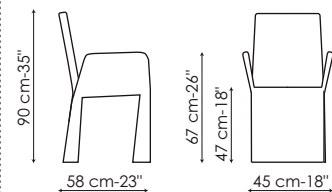

LIAS



①
FINITURA RIVESTIMENTO / UPHOLSTERY FINISH /
BEZUG AUSFÜHRUNG / FINITION REVÊTEMENT

RIVESTIMENTO

pelle
ecopelle
tessuto

UPHOLSTERY

leather
eco-leather
fabric

BEZUG

Leder
Kunstleder
Stoff

REVÊTEMENT

cuir souple
éco-cuir
tissu

②
FINITURA BASE / BASE FINISH / BASIS AUSFÜHRUNG / FINITION BASE

LEGNO MASSELLO



METALLO FINITURA

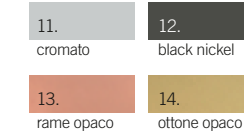

METALLO VERNICIATO OPACO



SOLID WOOD

1. ash polished natural
2. ash polished grey
3. walnut painted ash

MASSIVHOLZ

1. Eschen Natural poliert
2. Eschen Grau poliert
3. Esche nussbaumfarbig lackiert

BOIS MASSIF

1. frêne naturel brossé
2. frêne gris brossé
3. frêne teinté noyer

MAT PAINTED METAL

4. white
5. anthracite grey
6. dove grey
7. black
8. bordeaux
9. racing green
10. coffee brown

METALL MATT LACKIERT

4. Weiss
5. Anthrazitgrau
6. Taubengrau
7. Schwarz
8. Bordeaux
9. Racing green
10. Boffee brown

METAL VERNI OPAQUE

4. blanc
5. gris anthracite
6. gris tourterelle
7. noir
8. bordeaux
9. racing green
10. coffee brown

METAL FINISH

11. chrome
12. black nickel
13. mat copper
14. mat brass

METALL AUSFÜHRUNG

11. Verchromt
12. Schwarz vernickelt
13. Kupfer matt
14. Messing matt

FINITION MÉTAL

11. chromé
12. noir nickel
13. cuivre opaque
14. laiton opaque

DIMENSIONI / DIMENSIONS / GRÖßEN / DIMENSIONS

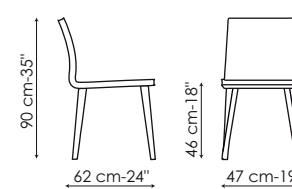

LIRY, LIRY UP



①
FINITURA RIVESTIMENTO / UPHOLSTERY FINISH /
BEZUG AUSFÜHRUNG / FINITION REVÊTEMENT

RIVESTIMENTO

pelle
ecopelle
tessuto

UPHOLSTERY

leather
eco-leather
fabric

BEZUG

Leder
Kunstleder
Stoff

REVÊTEMENT

cuir souple
éco-cuir
tissu

DIMENSIONI / DIMENSIONS / GRÖßEN / DIMENSIONS

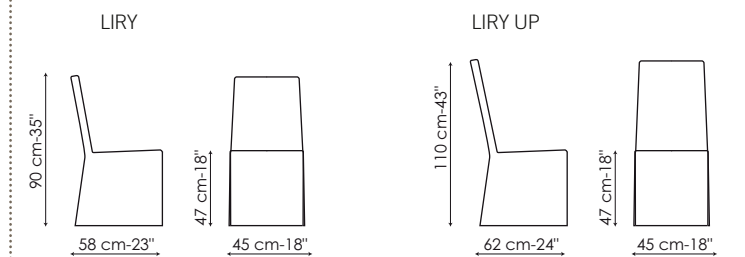

MISS LAMINA



①
**FINITURA RIVESTIMENTO / UPHOLSTERY FINISH /
 BEZUG AUSFÜHRUNG / FINITION REVÊTEMENT**

RIVESTIMENTO
 cuoio (cuciture e bordo in tinta)

UPHOLSTERY
 emery leather (with matching
 stitching and edge)

BEZUG
 Kernleder (Nähte und Rand
 gleichfarbig)

REVÊTEMENT
 cuir (coutures et bords de la
 même couleur)

FILLY UP TOO

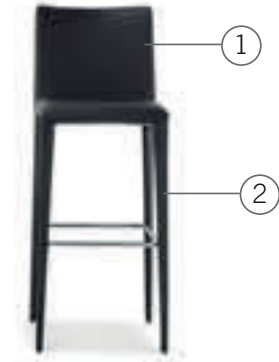

①
**FINITURA RIVESTIMENTO / UPHOLSTERY FINISH /
 BEZUG AUSFÜHRUNG / FINITION REVÊTEMENT**

RIVESTIMENTO
 pelle
 ecopelle
 tessuto

UPHOLSTERY
 leather
 eco-leather
 fabric

BEZUG
 Leder
 Kunstleder
 Stoff

REVÊTEMENT
 cuir souple
 éco-cuir
 tissu

②
FINITURA GAMBE / LEGS FINISH / BEINE AUSFÜHRUNG / FINITION PIEDS

VERNICIATO OPACO



METALLO FINITURA



RIVESTIMENTO
 pelle
 ecopelle
 tessuto

PAINTED MAT

1. white
2. anthracite grey
3. dove grey
4. bordeaux
5. coffee brown
6. racing green
7. arctic blue
8. brick red

LACKIERT MATT

1. Weiss
2. Anthrazitgrau
3. Taubengrau
4. Bordeaux
5. Coffee Brown
6. Racing Green
7. Arktisch blau
8. Ziegelrot

VERNI OPAQUE

1. blanc
2. gris anthracite
3. gris tourterelle
4. bordeaux
5. coffee brown
6. racing green
7. bleu arctique
8. brique

METAL FINISH

9. chrome
10. black nickel

METALL AUSFÜHRUNG

9. Verchromt
10. Schwarz vernickelt

FINITION MÉTAL

9. chromé
10. noir nickel

UPHOLSTERY

leather
 eco-leather
 fabric

BEZUG

Leder
 Kunstleder
 Stoff

REVÊTEMENT

cuir souple
 éco-cuir
 tissu

DIMENSIONI / DIMENSIONS / GRÖßEN / DIMENSIONS

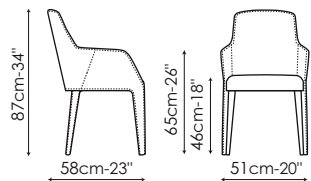

DIMENSIONI / DIMENSIONS / GRÖßEN / DIMENSIONS

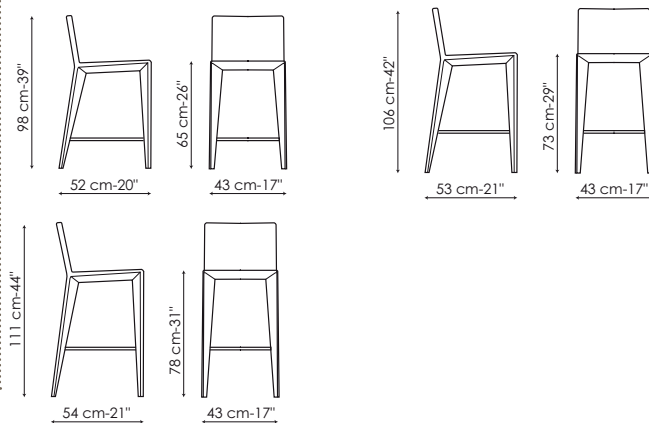

MILLE CONSOLE

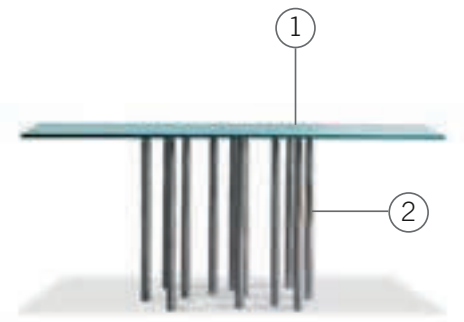

①

FINITURA PIANO / TOP FINISH / PLATTE AUSFÜHRUNG / FINITION PLAN

CRISTALLO

- 1. trasparente

②

FINITURA GAMBE / LEGS FINISH / BEINE AUSFÜHRUNG / FINITION PIEDS

FINITURA

- 1. cromato

TOP FINISH

- 1. transparent glass

PLATTE AUSFÜHRUNG

- 1. Klarglas

FINITION PLAN

- 1. cristal transparent

LEGS FINISH

- 1. chrome-plated

BEINE AUSFÜHRUNG

- 1. Verchromt

FINITION PIEDS

- 1. chromé

DIMENSIONI / DIMENSIONS / GRÖßEN / DIMENSIONS

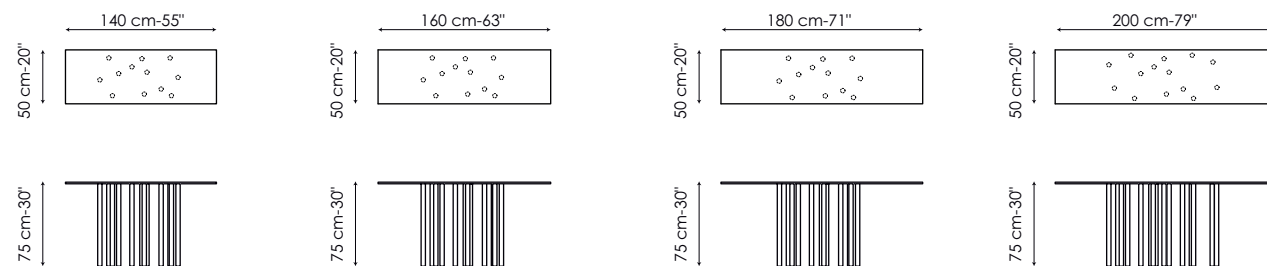

ORIGAMI CONSOLE



①

FINITURA PIANO / TOP FINISH / PLATTE AUSFÜHRUNG / FINITION PLAN

LEGNO MASSICCIO

- 1. noce americano
- 2. rovere spazzolato naturale
- 3. rovere spaz. grigio antracite

LEGNO CON BORDI NATURALI

- 4. noce americano

CERAMICA LUCIDA

- 5. Calacatta
- 6. Paonazzetto

CERAMICA LUCIDA

- 7. bianco iridium
- 8. grigio grafite
- 9. grigio Ardesia

SOLID WOOD

- 1. American walnut
- 2. natural polished oak
- 3. anthracite grey polished oak

MASSIVHOLZ

- 1. Amerikaner Nussbaum
- 2. Eiche Natur poliert
- 3. Eiche Anthrazitgrau poliert

WOOD WITH NATURAL EDGES

- 4. American walnut

HOLZ MIT WALDKANTE

- 4. Amerikaner Nussbaum

GLOSSY CERAMIC

- 5. Calacatta
- 6. Paonazzetto

GLÄNZEND KERAMIK

- 5. Calacatta
- 6. Paonazzetto

MAT CERAMIC

- 7. graphite grey
- 8. iridium white
- 9. Ardesia grey

MATT KERAMIK

- 7. Graphitgrau
- 8. Iridium Weiss
- 9. Ardesia Grau

BOIS MASSIF

- 1. noyer américain
- 2. rouvre brossé naturel
- 3. rouvre brossé gris anthracite

BOIS AVEC CONTOUR NATUREL

- 4. noyer américain

CÉRAMIQUE BRILLANT

- 5. Calacatta
- 6. Paonazzetto

CÉRAMIQUE OPAQUE

- 7. gris graphite
- 8. blanc iridium
- 9. gris Ardesia

②

FINITURA BASE / BASE FINISH / BASIS AUSFÜHRUNG / FINITION BASE

VERNICIATO OPACO

- 1. grigio antracite
- 2. bianco
- 3. bordeaux
- 4. tortora
- 5. marrone

METALLO FINITURA

- 6. brunito

MAT PAINTED

- 1. anthracite grey
- 2. white
- 3. bordeaux
- 4. dove grey
- 5. brown

LACKIERT MATT

- 1. Anthrazitgrau
- 2. Weiss
- 3. Bordeaux
- 4. Taubengrau
- 5. Braun

VERNI OPAQUE

- 1. gris anthracite
- 2. blanc
- 3. bordeaux
- 4. gris tourterelle
- 5. marron

METAL FINISH

- 6. burnished

METALL AUSFÜHRUNG

- 6. Brüniert

FINITION MÉTAL

- 6. bruni

DIMENSIONI / DIMENSIONS / GRÖßEN / DIMENSIONS

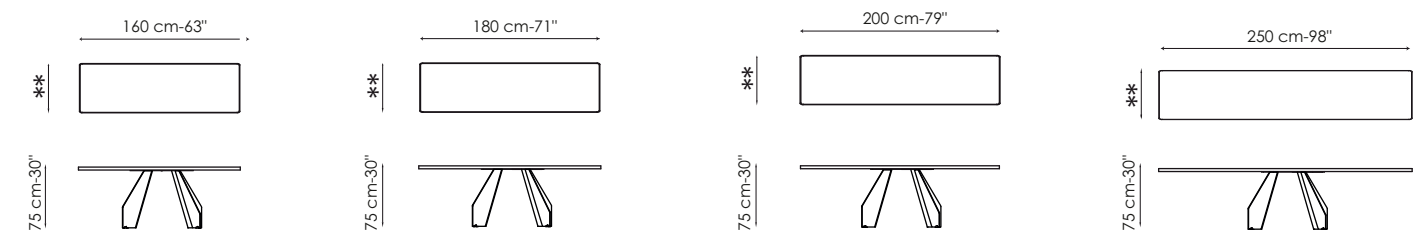

** 50 cm - 20"
legno / wood / Holz / bois
49 cm - 19,2"
ceramica / ceramic / Keramik / céramique

DOPPLER SIDEBORD

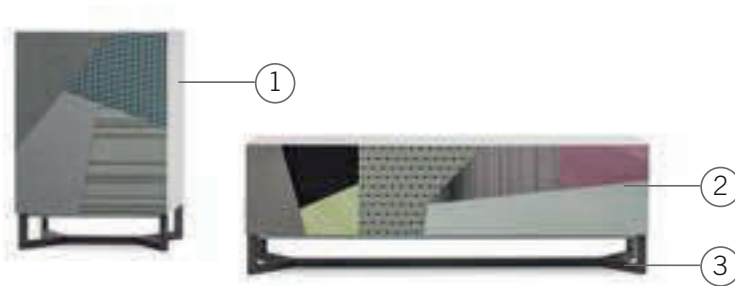

①
FINITURA STRUTTURA / FRAME FINISH / GESTELL AUSFÜHRUNG / FINITION STRUCTURE

ESTERNO
LACCATO OPACO

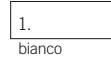

OUTSIDE
LACQUERED MAT

1. white

AUBEN
LACKIERT MATT

2. Weiss

EXTÉRIEUR
LAQUÉ OPAQUE

3. blanc

②
ANTE DECORATE
doors with decorative patterns
besonderen dekorierten Türen
portes décorées

③
FINITURA BASE / BASE FINISH / BASIS AUSFÜHRUNG / FINITION BASE

LEGNO MASSELLO



SOLID WOOD
1. walnut painted ash
2. natural ash
3. ash grey

MASSIVHOLZ
1. Eschen Nussbaumfarbig
lackiert
2. Eschen Natur
3. Eschen Grau

DIMENSIONI / DIMENSIONS / GRÖßEN / DIMENSIONS

LOW

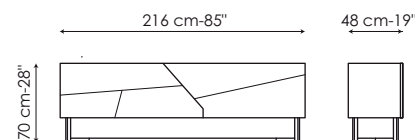

HIGH

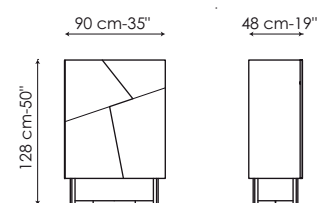

SHADE

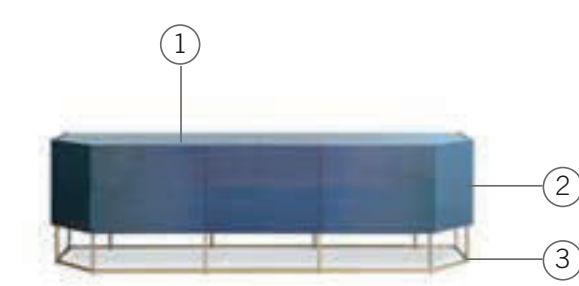

①
FINITURA STRUTTURA / FRAME FINISH / GESTELL AUSFÜHRUNG / FINITION STRUCTURE

ESTERNO
LACCATO OPACO



OUTSIDE
LACQUERED MAT

1. green

AUBEN
LACKIERT MATT

2. Grün

EXTÉRIEUR
LAQUÉ OPAQUE

3. vert

②
ANTE DECORATE
doors with decorative patterns
besonderen dekorierten Türen
portes décorées

③
FINITURA BASE / BASE FINISH / BASIS AUSFÜHRUNG / FINITION BASE

METALLO VERNICIATO OPACO

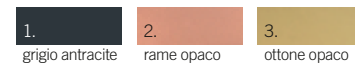

PAINTED MAT METAL
1. anthracite grey

MATT LACKIERT METALL
1. Anthrazitgrau

MÉTAL VERNI OPAQUE
1. gris anthracite

METAL FINISH
2. mat copper
3. mat brass

METALL AUSFÜHRUNG
2. Kupfer matt
3. Messing matt

FINITION MÉTAL
2. cuivre opaque
3. laiton opaque

DIMENSIONI / DIMENSIONS / GRÖßEN / DIMENSIONS

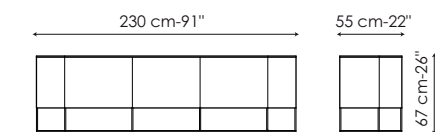
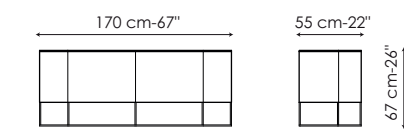

ARBOR

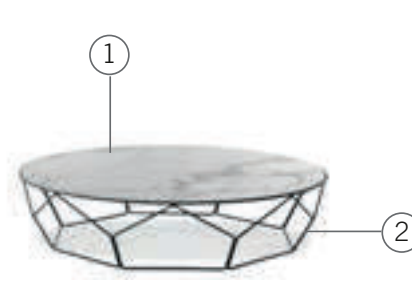

①
FINITURA PIANO / TOP FINISH / PLATTE AUSFÜHRUNG / FINITION PLAN

CRISTALLO EXTRACHIARO



CERAMICA LUCIDA



CERAMICA OPAQA



EXTRA-LIGHT GLASS
1. painted white
2. painted black
3. acid treated black
4. acid treated white

GLAS EXTRA-HELL
1. Weiss lackiert
2. Schwarz lackiert
3. Geätztes Schwarz
4. Geätztes Weiss

CRISTAL EXTRA-CLAIR
1. verni blanc
2. verni noir
3. traité à l'acide noir
4. traité à l'acide blanc

GLOSSY CERAMIC
5. Calacatta
6. Paonazzetto

GLÄNZEND KERAMIC
5. Calacatta
6. Paonazzetto

CÉRAMIQUE BRILLANT
5. Calacatta
6. Paonazzetto

MATT CERAMIC
7. iridium white (not Arbor Ø117)
8. graphite grey (not Arbor Ø117)
9. Ardesia grey

MATT KERAMIC
7. Iridium Weiss (nicht Arbor Ø117)
8. Graphitgrau (nicht Arbor Ø117)
9. Ardesia Grau

CÉRAMIQUE OPAQUE
7. blanc iridium (pas Arbor Ø117)
8. gris graphite (pas Arbor Ø117)
9. gris Ardesia

②
FINITURA STRUTTURA / FRAME FINISH / GESTELL AUSFÜHRUNG / FINITION STRUCTURE

METALLO VERNICIATO OPACO



METALLO FINITURA



DIMENSIONI / DIMENSIONS / GRÖßEN / DIMENSIONS

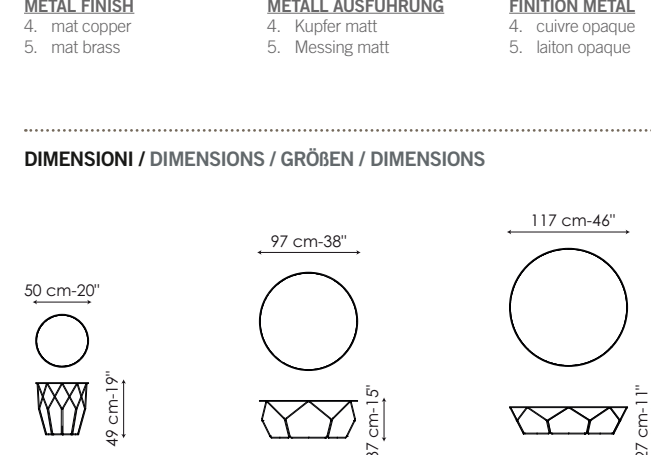

ASSEMBLAGE

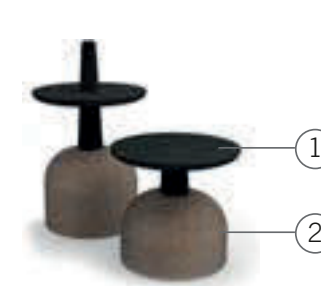

①
FINITURA PIANO / TOP FINISH / PLATTE AUSFÜHRUNG / FINITION PLAN

LEGNO MASSELLO



SOLID WOOD
1. ash polished natural
2. ash polished grey
3. walnut painted ash
4. black painted ash
5. royal blue painted ash
6. bordeaux painted ash

MASSIVHOLZ
7. Esche Natural poliert
8. Esche Grau poliert
9. Esche nussbaumfarbig
lackiert
10. Esche Schwarz lackiert
11. Esche Royal Blue lackiert
12. Esche Bordeaux lackiert

BOIS MASSIF
13. frêne naturel brossé
14. frêne gris brossé
15. frêne teinté noyer
16. frêne verni noir
17. frêne verni royal blue
18. frêne verni bordeaux

②
FINITURA BASE / BASE FINISH / BASIS AUSFÜHRUNG / FINITION BASE

FINITURA

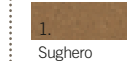

BASE FINISH

1. cork

BASIS AUSFÜHRUNG

1. Kork

FINITION BASE

1. liège

DIMENSIONI / DIMENSIONS / GRÖßEN / DIMENSIONS

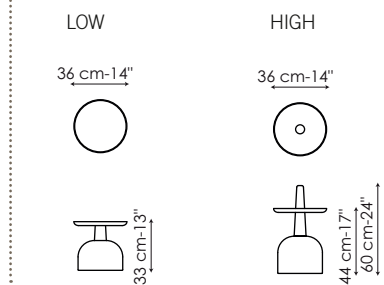

NEMESI, NEMESI LIGHT

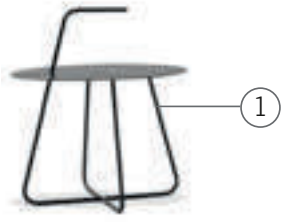

①

FINITURA STRUTTURA / FRAME FINISH / GESTELL AUSFÜHRUNG / FINITION STRUCTURE

NEMESI
METALLO VERNICIATO OPACO

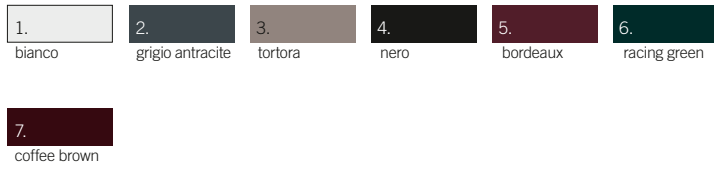

MAT POLYETHYLENE

- white
- black
- anthracite grey
- dove grey
- racing green
- coffee brown
- bordeaux

POLYETHYLEN MATT

- Weiss
- Schwarz
- Anthrazitgrau
- Taubengrau
- Racing green
- Coffee brown
- Bordeaux

POLYÉTHYLÈNE OPAQUE

- blanc
- noir
- gris tourterelle
- gris anthracite
- racing green
- coffee brown
- bordeaux

NEMESI LIGHT

METALLO VERNICIATO OPACO

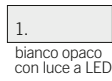

MAT POLYETHYLENE

- mat white with LED light

POLYETHYLEN MATT

- Weiss matt mit LED lampe

POLYÉTHYLÈNE OPAQUE

- blanc opaque avec lumière LED

DIMENSIONI / DIMENSIONS / GRÖßEN / DIMENSIONS

60 cm-24"



THEDUCK, THEDUCK LIGHT



①

FINITURA STRUTTURA / FRAME FINISH / GESTELL AUSFÜHRUNG / FINITION STRUCTURE

THEDUCK
POLIETILENE OPACO

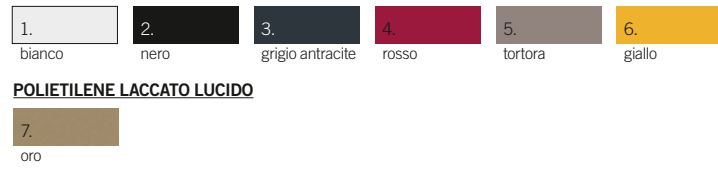

MAT POLYETHYLENE

- white
- nero
- anthracite grey
- red
- dove grey
- yellow

POLYETHYLEN MATT

- Weiss
- Schwarz
- Anthrazitgrau
- Rot
- Taubengrau
- Gelb

POLYÉTHYLÈNE OPAQUE

- blanc
- noir
- gris anthracite
- rouge
- gris tourterelle
- jaune

GLOSSY LACQUERED POLYETHYLENE

- gold

POLYETHYLEN GLÄNZED LACKIERT

- Gold

POLYÉTHYLÈNE LAQUÉ BRILLANT

- or

THEDUCK LIGHT

POLIETILENE

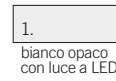

POLYETHYLENE

- mat white with LED light

POLYETHYLEN

- Weiss matt mit LED lampe

POLYÉTHYLÈNE

- blanc opaque avec lumière LED

DIMENSIONI / DIMENSIONS / GRÖßEN / DIMENSIONS

48 cm-19"



DOPPLER LIGHT

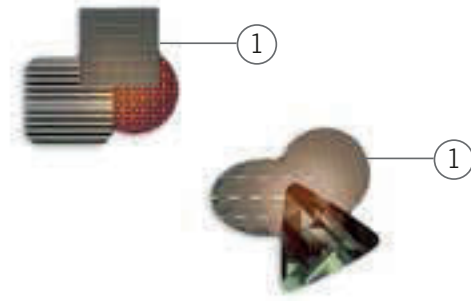

①

FINITURA STRUTTURA / FRAME FINISH / GESTELL AUSFÜHRUNG / FINITION STRUCTURE

- crystal serigrafato

1. silkscreened glass

1. Siebdruck-Glas

1. cristal sérigraphié

DIMENSIONI / DIMENSIONS / GRÖßEN / DIMENSIONS

DOPPLER 1

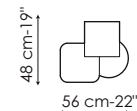

DOPPLER 2



MUFFIN LAMP

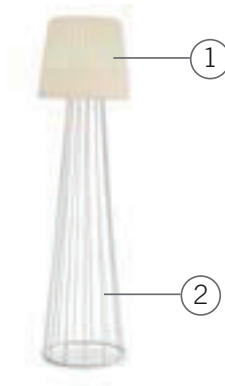

①

PARALUME / LAMP SHADE / LAMPENSCHIRM / PARALUME

POLIETILENE OPACO

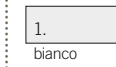

MAT POLYETHYLENE

- white

POLYETHYLEN MATT

- Weiss

POLYÉTHYLÈNE OPAQUE

- blanc

②

FINITURA STRUTTURA / FRAME FINISH / GESTELL AUSFÜHRUNG / FINITION STRUCTURE

METALLO VERNICIATO OPACO



MAT PAINTED

- white
- red
- anthracite grey

LACKIERT MATT

- Weiss
- Rot
- Anthrazitgrau

VERNI OPAQUE

- blanc
- rouge
- gris anthracite

DIMENSIONI / DIMENSIONS / GRÖßEN / DIMENSIONS

47 cm-19"

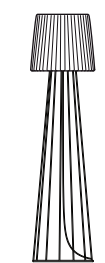

RAIN



①

FINITURA STRUTTURA / FRAME FINISH / GESTELL AUSFÜHRUNG / FINITION STRUCTURE

METALLO VERNICIATO OPACO



1. grigio antracite 2. tortora 3. marrone 4. nero 5. rame opaco 6. ottone opaco

METALLO FINITURA

PAINTED MAT METAL

1. anthracite grey
2. dove grey
3. brown
4. black

MATT LACKIERT METALL

1. Anthrazitgrau
2. Taubengrau
3. Braun
4. Schwarz

MÉTAL VERNI OPAQUE

1. gris anthracite
2. gris tourterelle
3. marron
4. noir

METAL FINISH

5. mat copper
6. mat brass

METALL AUSFÜHRUNG

5. Kupfer matt
6. Messing matt

FINITION MÉTAL

5. cuivre opaque
6. laiton opaque

②

FINITURA PIANO / TOP FINISH / PLATTE AUSFÜHRUNG / FINITION PLAN

LEGNO IMPIALLACCIATO

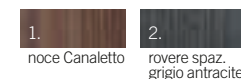

1. noce Canaletto 2. rovere spaz. grigio antracite

VENEERED WOOD

1. walnut Canaletto
2. anthracite grey polished oak

HOLZ FURNIERT

1. Nussbaum Canaletto
2. Eiche Anthrazitgrau poliert

BOIS PLAQUÉ

1. noyer Canaletto
2. rouvre brossé gris anthracite

DIMENSIONI / DIMENSIONS / GRÖßEN / DIMENSIONS

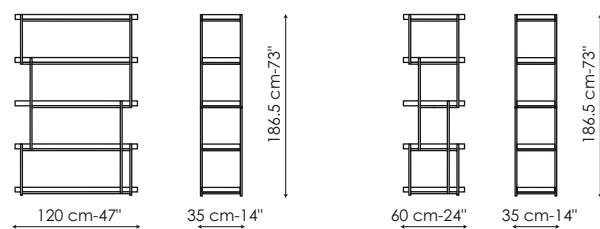

COLORS



①

RIVESTIMENTO / COVER / BEZUG / REVÊTEMENT

RIVESTIMENTO

pelle
tessuto

UPHOLSTERY

leather
fabric

BEZUG

Leder
Stoff

REVÊTEMENT

cuir souple
tissu

②

FASCIA / BAND / STREIFEN / BANDE

solo versione tessuto / only fabric version / nur Stoffvariante / seulement version en tissu

228

disponibile in vari tessuti
(vedere listino)

available in many
fabrics
(see price list)

verfügbar in mehreren Stoff
varianten
(siehe Preisliste)

disponible dans plusieurs
tissus
(voir liste des prix)

③

PIEDI / FEET / FÜßE / PIEDS

METALLO VERNICIATO OPACO



METALLO FINITURA



MAT PAINTED METAL

1. anthracite grey
2. dove grey
3. brown
4. amaranth
5. white
6. black

LACKIERT MATT METAL

1. Anthrazitgrau
2. Taubengrau
3. Braun
4. Amaranth
5. Weiss
6. Schwarz

METAL VERNI OPAQUE

1. gris anthracite
2. gris tourterelle
3. marron
4. amarante
5. blanc
6. noir

METAL FINISH

7. chrome
8. black nickel
9. copper bronze

METALL AUSFÜHRUNG

7. Verchromt
8. Schwarz vernickelt
9. Kupferbronze

FINITION MÉTAL

7. chromé
8. noir nickel
9. bronze cuivre

**DIMENSIONI / DIMENSIONS / GRÖßEN / DIMENSIONS
PROFONDITÀ 90 / DEPTH 90 / TIEFE 90 / PROFONDEUR 90**

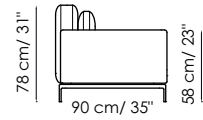

**Divano / Sofa / Sofa / Canapé
180**

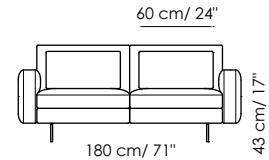

210

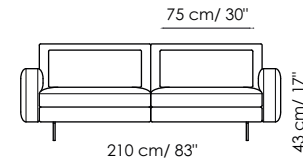

240

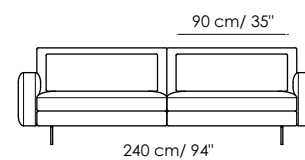

Terminale dx o sx / End section right or left / Endteil recht oder links / Élément terminal droite ou gauche

165

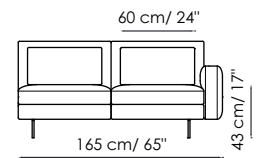

DESTRA / RIGHT / RECHT / DROIT

195

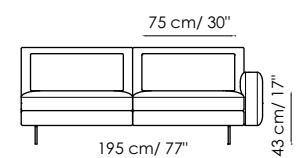

225

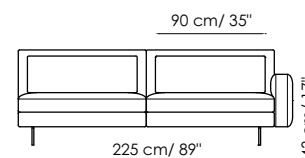

Angolare dx o sx / Corner sofa right or left / Ecksofa recht oder links / Canapé d'angle droite ou gauche

195

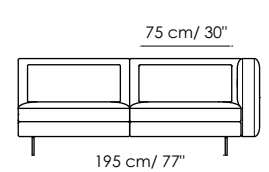

DESTRA / RIGHT / RECHT / DROIT

225

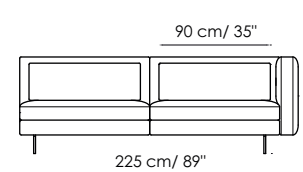

Chaise longue dx o sx / right or left / recht oder links / droite ou gauche

150

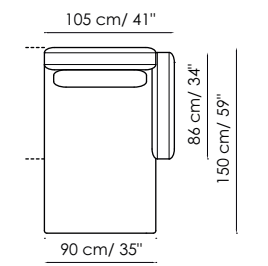

DESTRA / RIGHT / RECHT / DROIT

195

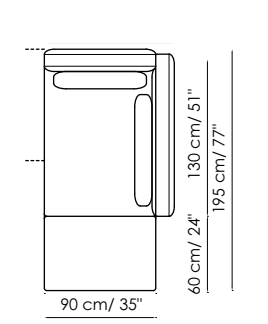

Pouf 90x90

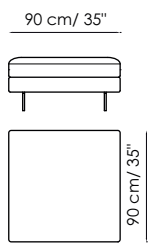

**DIMENSIONI / DIMENSIONS / GRÖßEN / DIMENSIONS
PROFONDITÀ 105 / DEPTH 105 / TIEFE 105 / PROFONDEUR 105**

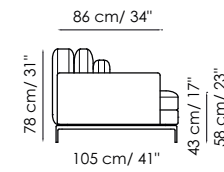

Divano / Sofa / Sofa / Canapé

210

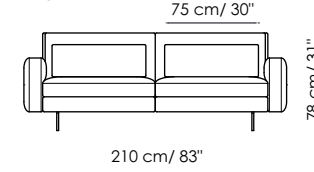

240

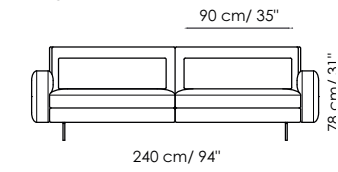

Terminale dx o sx / End section right or left / Endteil recht oder links / Élément terminal droite ou gauche

225

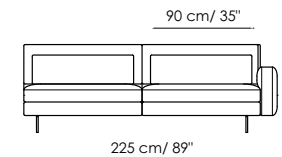

DESTRA / RIGHT / RECHT / DROIT

Angolare dx o sx / Corner sofa right or left / Ecksofa recht oder links / Canapé d'angle droite ou gauche

225

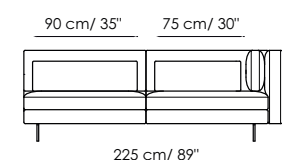

DESTRA / RIGHT / RECHT / DROIT

Chaise longue dx o sx / right or left / recht oder links / droite ou gauche

180

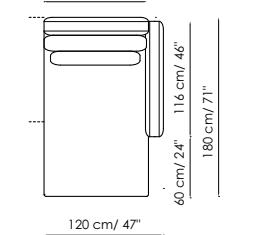

DESTRA / RIGHT / RECHT / DROIT

SKID



①

RIVESTIMENTO / COVER / BEZUG / REVÊTEMENT

RIVESTIMENTO

pelle
ecopelle
tessuto

UPHOLSTERY

leather
eco-leather
fabric

BEZUG

Leder
Kunstleder
Stoff

REVÊTEMENT

cuir souple
éco-cuir
tissu

②

PIEDI / FEET / FÜÙE / PIEDS

(disponibile con piedi o base a slitta) / (available with feet or sliding base) / (mit FüÙe oder mit Kufenbasis erhältlich) / (disponible avec pieds ou coulisse)

METALLO VERNICIATO OPACO

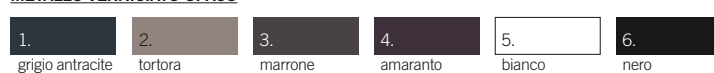

METALLO FINITURA



MAT PAINTED METAL

1. anthracite grey
2. dove grey
3. brown
4. amaranth
5. white
6. black

METAL FINISH

7. chrome
8. black nickel
9. copper bronze

LACKIERT MATT METAL

1. Anthrazitgrau
2. Taubengrau
3. Braun
4. Amaranth
5. Weiss
6. Schwarz

METALL AUSFÜHRUNG

7. Verchromt
8. Schwarz vernickelt
9. Kupferbronze

METAL VERNI OPAQUE

1. gris anthracite
2. gris tourterelle
3. marron
4. amarante
5. blanc
6. noir

FINITION MÉTAL

7. chromé
8. noir nickel
9. bronze cuivre

DIMENSIONI / DIMENSIONS / GRÖÙEN / DIMENSIONS

Divano / Sofa / Sofa / Canapé

190

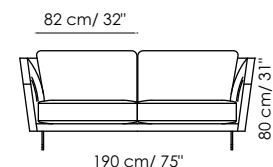
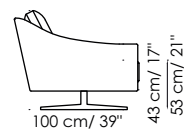

220

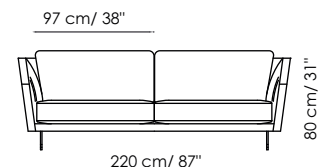

250

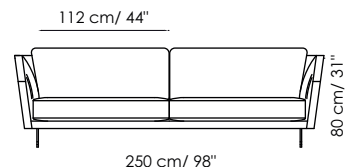

Terminale dx o sx / End section right or left / Endteil recht oder links / Élément terminal droite ou gauche

170

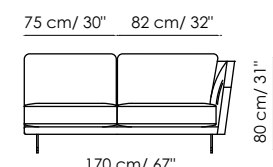
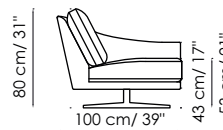

200

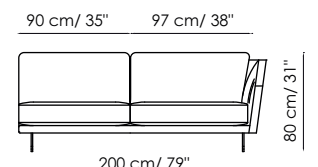

230

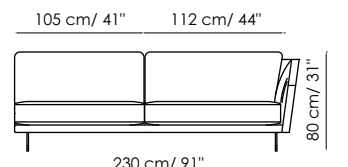

DESTRA / RIGHT / RECHT / DROIT

Angolare dx o sx / Corner sofa right or left / Ecksofa recht oder links / Canapé d'angle droite ou gauche

220

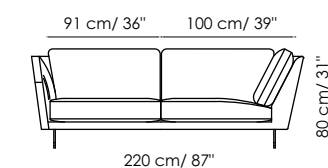
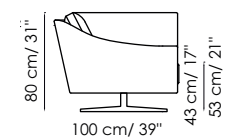

DESTRA / RIGHT / RECHT / DROIT

250

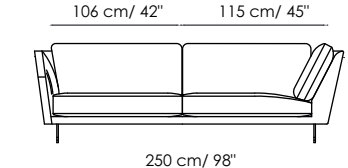

Chaise longue dx o sx / right or left / recht oder links / droite ou gauche

170

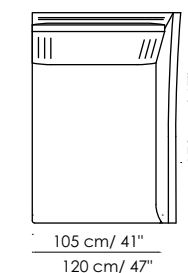

DESTRA / RIGHT / RECHT / DROIT

Angolo

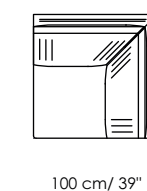

Meridiana 230

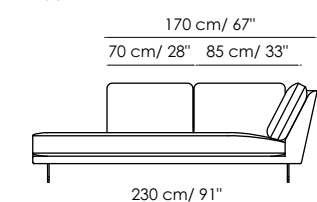

DESTRA / RIGHT / RECHT / DROIT

260

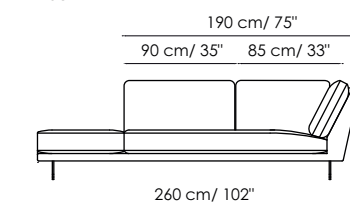

Dormeuse 260

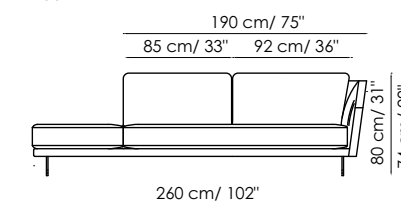

DESTRA / RIGHT / RECHT / DROIT

Pouf

87x87

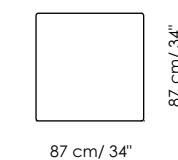
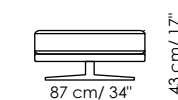

120x70

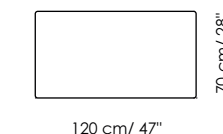
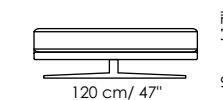

120x120

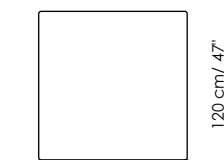
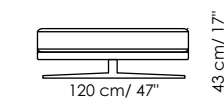

120 cm / 47"

LOVY



①

RIVESTIMENTO / COVER / BEZUG / REVÊTEMENT

RIVESTIMENTO

pelle
tessuto

UPHOLSTERY

leather
fabric

BEZUG

Leder
Stoff

REVÊTEMENT

cuir souple
tissu

②

PIEDI / FEET / FÜßE / PIEDS

METALLO VERNICIATO OPACO



METALLO FINITURA



MAT PAINTED METAL

1. anthracite grey
2. dove grey
3. brown
4. amaranth
5. white
6. black

METAL FINISH

7. chrome
8. black nickel
9. copper bronze

LACKIERT MATT METAL

1. Anthrazitgrau
2. Taubengrau
3. Braun
4. Amaranth
5. Weiss
6. Schwarz

METALL AUSFÜHRUNG

7. Verchromt
8. Schwarz vernickelt
9. Kupferbronze

METAL VERNI OPAQUE

1. gris anthracite
2. gris tourterelle
3. marron
4. amarante
5. blanc
6. noir

FINITION MÉTAL

7. chromé
8. noir nickel
9. bronze cuivre

DIMENSIONI / DIMENSIONS / GRÖßEN / DIMENSIONS



Divano / Sofa / Sofa / Canapé

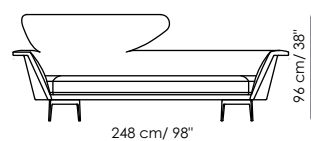

Cuscino / cushion / Kissen / Coussin

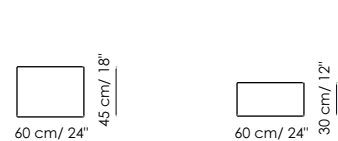

ALFIE ARM



①

FINITURA RIVESTIMENTO / UPHOLSTERY FINISH / BEZUG AUSFÜHRUNG / FINITION REVÊTEMENT

RIVESTIMENTO

pelle
ecopelle
tessuto

UPHOLSTERY

leather
eco-leather
fabric

BEZUG

Leder
Kunstleder
Stoff

REVÊTEMENT

cuir souple
éco-cuir
tissu

②

SCOCCA / BASE FINISH / SITZFLÄCHE AUSFÜHRUNG / FINITION BASE

RIVESTIMENTO

cuoio

UPHOLSTERY

emery leather

BEZUG

Kernleder

REVÊTEMENT

cuir

③

FINITURA BASE / BASE FINISH / BASIS AUSFÜHRUNG / FINITION BASE

VERNICIATO OPACO

1. bianco
2. grigio antracite
3. rosso

METALLO FINITURA

4. cromato
5. black nickel

PAINTED MAT

1. white
2. anthracite grey
3. red

METAL FINISH

4. chrome
5. black nickel

LACKIERT MATT

1. Weiss
2. Anthrazitgrau
3. Rot

METALL AUSFÜHRUNG

4. Verchromt
5. Schwarz vernickelt

VERNI OPAQUE

1. blanc
2. gris anthracite
3. rouge

FINITION MÉTAL

4. chromé
5. noir nickel

DIMENSIONI / DIMENSIONS / GRÖßEN / DIMENSIONS

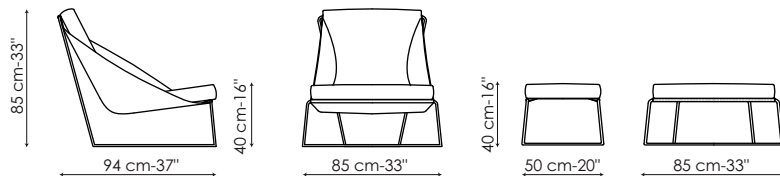

ARNO



①

FINITURA RIVESTIMENTO / UPHOLSTERY FINISH / BEZUG AUSFÜHRUNG / FINITION REVÊTEMENT

RIVESTIMENTO

pelle
ecopelle
tessuto

UPHOLSTERY

leather
eco-leather
fabric

BEZUG

Leder
Kunstleder
Stoff

REVÊTEMENT

cuir souple
éco-cuir
tissu

②

FINITURA BASE / BASE FINISH / BASIS AUSFÜHRUNG / FINITION BASE

RIVESTIMENTO

cuoio

UPHOLSTERY

emery leather

BEZUG

Kernleder

REVÊTEMENT

cuir

③

FINITURA BASE / BASE FINISH / BASIS AUSFÜHRUNG / FINITION BASE

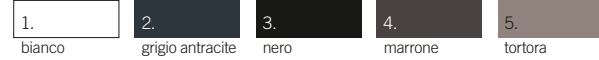
METALLO VERNICIATO OPACO

1. bianco
2. grigio antracite
3. nero
4. marrone
5. tortora

MAT PAINTED METAL

1. white
2. anthracite grey
3. black
4. brown
5. dove grey

MATT METALL LACKIERT

1. Weiss
2. Anthrazitgrau
3. Schwarz
4. Braun
5. Taubengrau

MÉTAL VERNI OPAQUE

1. blanc
2. gris anthracite
3. noir
4. marron
5. gris tourterelle

DIMENSIONI / DIMENSIONS / GRÖßEN / DIMENSIONS

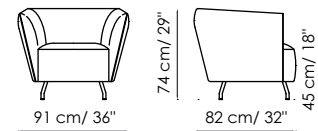

BODO



①

FINITURA RIVESTIMENTO / UPHOLSTERY FINISH / BEZUG AUSFÜHRUNG / FINITION REVÊTEMENT

RIVESTIMENTO

pelle
tessuto

UPHOLSTERY

leather
fabric

BEZUG

Leder
Stoff

REVÊTEMENT

cuir souple
tissu

②

INSERTO / INSERT / EINLAGE / INSERT

pelle Capri

Leather Capri

Leder Capri

cuir souple Capri

③

FINITURA BASE / BASE FINISH / BASIS AUSFÜHRUNG / FINITION BASE

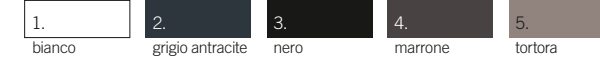
METALLO VERNICIATO OPACO

1. bianco
2. grigio antracite
3. nero
4. marrone
5. tortora

MAT PAINTED METAL

1. white
2. anthracite grey
3. black
4. brown
5. dove grey

MATT METALL LACKIERT

1. Weiss
2. Anthrazitgrau
3. Schwarz
4. Braun
5. Taubengrau

MÉTAL VERNI OPAQUE

1. blanc
2. gris anthracite
3. noir
4. marron
5. gris tourterelle

DIMENSIONI / DIMENSIONS / GRÖßEN / DIMENSIONS

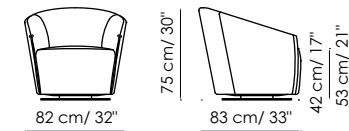

BRUNO



①

FINITURA RIVESTIMENTO / UPHOLSTERY FINISH / BEZUG AUSFÜHRUNG / FINITION REVÊTEMENT

RIVESTIMENTO

pelle
tessuto

UPHOLSTERY

leather
fabric

BEZUG

Leder
Stoff

REVÊTEMENT

cuir souple
tissu

②

INSERTO / INSERT / EINLAGE / INSERT

pelle Capri

Leather Capri

Leder Capri

cuir souple Capri

③

FINITURA BASE / BASE FINISH / BASIS AUSFÜHRUNG / FINITION BASE

METALLO VERNICIATO OPACO

1. bianco
2. grigio antracite
3. nero
4. marrone
5. tortora

MAT PAINTED METAL

1. white
2. anthracite grey
3. black
4. brown
5. dove grey

MATT METALL LACKIERT

1. Weiss
2. Anthrazitgrau
3. Schwarz
4. Braun
5. Taubengrau

MÉTAL VERNI OPAQUE

1. blanc
2. gris anthracite
3. noir
4. marron
5. gris tourterelle

DIMENSIONI / DIMENSIONS / GRÖßEN / DIMENSIONS

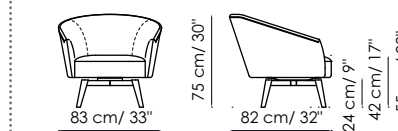

EDDY, EDDY UP

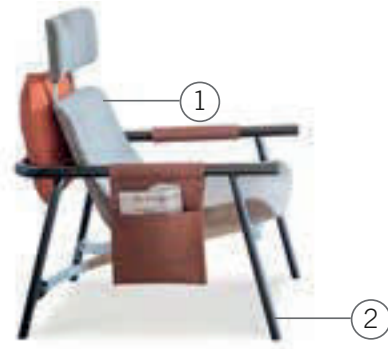

①

FINITURA RIVESTIMENTO / UPHOLSTERY FINISH /
BEZUG AUSFÜHRUNG / FINITION REVÊTEMENT

RIVESTIMENTO

pelle
ecopelle
tessuto

UPHOLSTERY

leather
eco-leather
fabric

BEZUG

Leder
Kunstleder
Stoff

REVÊTEMENT

cuir souple
éco-cuir
tissu

②

FINITURA STRUTTURA / FRAME FINISH / STRUKTUR AUSFÜHRUNG / FINITION
STRUCTURE

VERNICIATO OPACO



METALLO



PAINTED MAT METAL

1. white
2. anthracite grey
3. dove grey
4. black
5. bordeaux
6. racing green
7. coffee brown

MATT LACKIERT METALL

1. Weiss
2. Anthrazitgrau
3. Taubengrau
4. Schwarz
5. Bordeaux
6. Racing green
7. Coffee brown

MÉTAL VERNI OPAQUE

1. blanc
2. gris anthracite
3. gris tourterelle
4. noir
5. bordeaux
6. racing green
7. coffee brown

METAL FINISH

8. mat copper
9. mat brass

METALL AUSFÜHRUNG

8. Kupfer matt
9. Messing matt

FINITION MÉTAL

8. cuivre opaque
9. laiton opaque

DIMENSIONI / DIMENSIONS / GRÖßEN / DIMENSIONS

EDDY

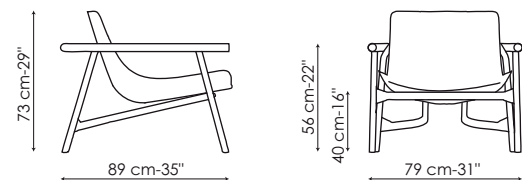

EDDY UP

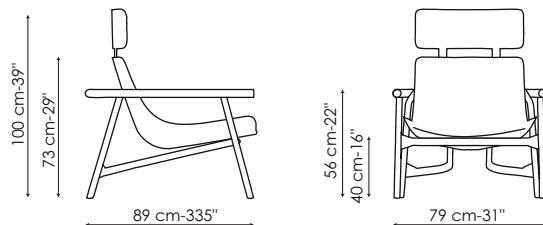

LOCK



①

FINITURA RIVESTIMENTO / UPHOLSTERY FINISH /
BEZUG AUSFÜHRUNG / FINITION REVÊTEMENT

RIVESTIMENTO (disponibile anche bicolore).

pelle
ecopelle
tessuto

UPHOLSTERY
(also available two-toned)

leather
eco-leather
fabric

BEZUG
(auch zweifarbig erhältlich)

Leder
Kunstleder
Stoff

REVÊTEMENT
(disponible aussi bi-couleur)

cuir souple
éco-cuir
tissu

②

FINITURA STRUTTURA / FRAME FINISH / STRUKTUR AUSFÜHRUNG / FINITION
STRUCTURE

VERNICIATO OPACO



METALLO



PAINTED MAT METAL

1. white
2. anthracite grey
3. dove grey
4. black
5. bordeaux
6. racing green
7. coffee brown
8. amaranth

MATT LACKIERT METALL

1. Weiss
2. Anthrazitgrau
3. Taubengrau
4. Schwarz
5. Bordeaux
6. Racing green
7. Coffee brown
8. Amaranth

MÉTAL VERNI OPAQUE

1. blanc
2. gris anthracite
3. gris tourterelle
4. noir
5. bordeaux
6. racing green
7. coffee brown
8. amarante

METAL FINISH

9. chrome
10. black nickel
11. mat copper
12. mat brass

METALL AUSFÜHRUNG

9. Verchromt
10. Schwarz vernickelt
11. Kupfer matt
12. Messing matt

FINITION MÉTAL

9. chromé
10. noir nickel
11. cuivre opaque
12. laiton opaque

DIMENSIONI / DIMENSIONS / GRÖßEN / DIMENSIONS

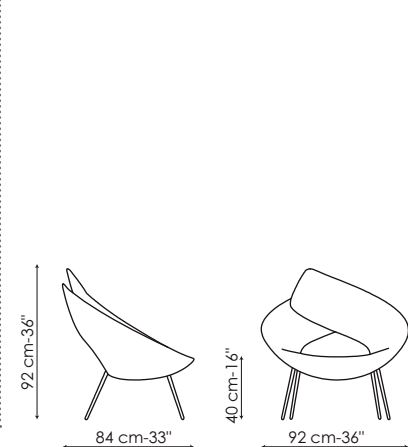

BLANKET



① **FINITURE RIVESTIMENTO / UPHOLSTERY FINISH / BEZUG AUSFÜHRUNG / FINITIONS REVÊTEMENT**

RIVESTIMENTO
tessuto

UPHOLSTERY
fabric

BEZUG
Stoff

REVÊTEMENT
tissu

② **PIEDI / FEET / FÜÙE / PIEDS**

METALLO VERNICIATO OPACO

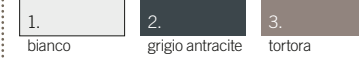

MAT PAINTED METAL

- 1. white
- 2. anthracite grey
- 3. dove grey

METALL LACKIERT MATT

- 1. Weiss
- 2. Anthrazitgrau
- 3. Taubengrau

MÉTAL VERNI OPAQUE

- 1. blanc
- 2. gris anthracite
- 3. gris tourterelle

DIMENSIONI / DIMENSIONS / GRÖÙEN / DIMENSIONS

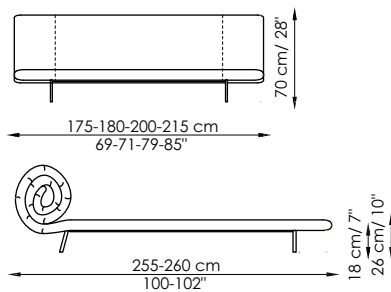

GALA



① **FINITURA STRUTTURA / FRAME FINISH / GESTELL AUSFÜHRUNG / FINITION STRUCTURE**

IMPIALLACCIATO LEGNO



VENEERED WOOD
1. walnut Canaletto

HOLZ FURNIERT
1. Nussbaum Canaletto

BOIS PLAQUÉ
1. noyer Canaletto

② **FINITURA MANIGLIA / HANDLE FINISH / GRIFF AUSFÜHRUNG / FINITION POIGNÉE**

LACCATO OPACO



MAT LACQUERED
1. anthracite grey

MATT LACKIERT
1. Anthrazitgrau

LAQUÉ OPAQUE
1. gris anthracite

③ **FINITURA BASE / BASE FINISH / BASIS AUSFÜHRUNG / FINITION BASE**

VERNICIATO OPACO



METALLO FINITURA



MAT PAINTED
1. anthracite grey

METAL FINISH
2. burnished

MATT LACKIERT
1. Anthrazitgrau

METALL AUSFÜHRUNG
2. Brüniert

VERNI OPAQUE
1. gris anthracite

FINITION MÉTAL
2. bruni

DIMENSIONI / DIMENSIONS / GRÖÙEN / DIMENSIONS

COMODINO CON 1 CASSETTO / BEDSIDE TABLE WITH ONE DRAWER / NACHTTISCH MIT EINER SCHUBLADE / TABLE DE NUIT AVEC UN TIROIR

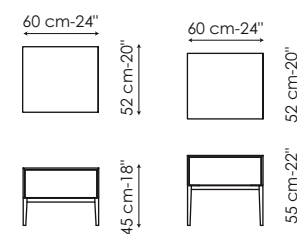

COMODINO CON 2 CASSETTI / BEDSIDE TABLE WITH TWO DRAWERS / NACHTTISCH MIT ZWEI SCHUBLADEN / TABLE DE NUIT AVEC DEUX TIROIRS /

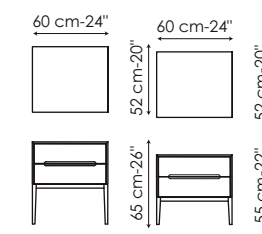

COMÒ / DRAWER CHEST / KOMMODE / KOMMODE

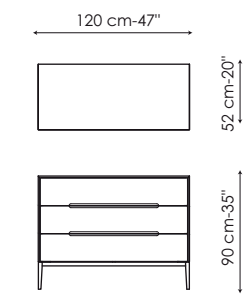

SETTIMANALE / HIGHBOY / HOHER KOMMODE MIT SIEBEN SCHUBLADEN / SEMAINIER

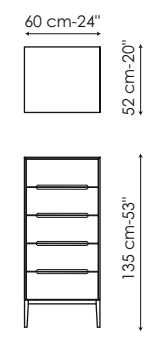



①

FINITURA STRUTTURA / FRAME FINISH / GESTELL AUSFÜHRUNG / FINITION STRUCTURE

IMPIALLACCIATO LEGNO



1. noce Canaletto

VENEERED WOOD
1. walnut Canaletto

HOLZ FURNIERT
1. Nussbaum Canaletto

BOIS PLAQUÉ
1. noyer Canaletto

②

FINITURA MANIGLIA / HANDLE FINISH / GRIFF AUSFÜHRUNG / FINITION POIGNÉE

LACCATO OPACO

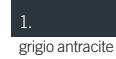

1. grigio antracite

MAT LACQUERED
1. anthracite grey

MATT LACKIERT
1. Anthrazitgrau

LAQUÉ OPAQUE
1. gris anthracite

③

FINITURA BASE / BASE FINISH / BASIS AUSFÜHRUNG / FINITION BASE

VERNICIATO OPACO

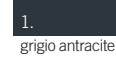

1. grigio antracite

MAT PAINTED
1. anthracite grey

METAL FINISH
2. burnished

METALLO FINITURA

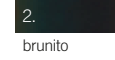

2. brunito

MATT LACKIERT
1. Anthrazitgrau

METALL AUSFÜHRUNG
2. Brüniert

VERNI OPAQUE
1. gris anthracite

FINITION MÉTAL
2. bruni

DIMENSIONI / DIMENSIONS / GRÖßEN / DIMENSIONS

COMODINO CON 1 CASSETTO /
BEDSIDE TABLE WITH ONE DRAWER /
NACHTTISCH MIT EINER SCHUBLADE /
TABLE DE NUIT AVEC UN TIROIR

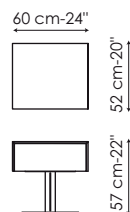

COMODINO CON 2 CASSETTI /
BEDSIDE TABLE WITH TWO DRAWERS /
NACHTTISCH MIT ZWEI SCHUBLADEN /
TABLE DE NUIT AVEC DEUX TIROIRS /

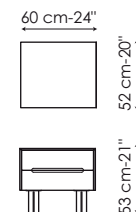

COMÒ /
DRAWER CHEST /
KOMMODE /
KOMMODE

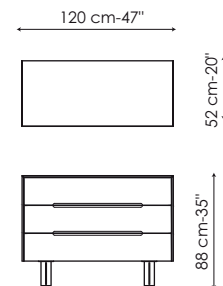

SETTIMANALE /
HIGHBOY /
HOHER KOMMODE MIT
SIEBEN SCHUBLADEN /
SEMMAINIER

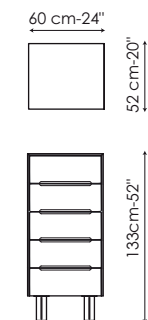

METALLI / METALS / METALLE / MÉTAUX

VERNICIATO OPACO / MAT PAINTED / LACKIERT MATT / VERNI OPAQUE

BIG TABLE

COMBINAZIONE 3 / COMBINATION 3 / KOMBINATION 3 / COMBINAISON 3



brass yellow



royal blue



racing green



bordeaux

COP

COMBINAZIONE 1 / COMBINATION 1 / KOMBINATION 1 / COMBINAISON 1



a1.dove grey - a2.brown

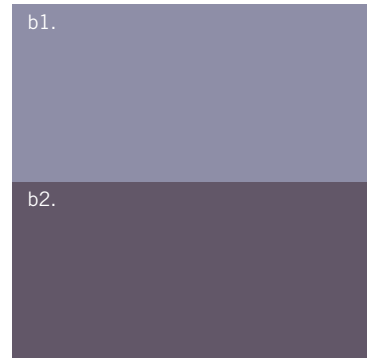

b1.lilac - b2.plum

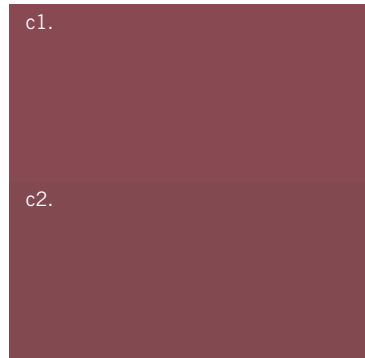

c1.orchid - c2.raspberry

CERAMICA OPACA / MAT CERAMIC / MATT KERAMIC / CÉRAMIQUE OPAQUE



grigio Ardesia
Ardesia grey
Ardesia Grau
gris Ardesia

concept
romanoassociati.com

photographer
Beppe Brancato
Paolo Golumelli

styling
Laura Cazzaniga
Ilaria Limonta
Studio Salaris

press
O.G.M. SpA

Printed in Italy
July 2017

Thanks to
Amini
Artemide
Astep
Axo Light
Carpet Edition
Francesco Perego
Fürstenberg
Gibas Lighting
Incipit Lab
London Art
M A N I Ceramiche
Mm Lampadari
Mohebban
Paola Paronetto
Society
Square Garden
Tooy
Torremato

Bonaldo SpA si riserva di modificare, senza preavviso, materiali, rivestimenti, finiture e disegni dei prodotti presentati in questo catalogo. I colori e le finiture visualizzate sono puramente indicativi e possono differire dagli originali. Le immagini riprodotte nel presente catalogo sono di proprietà esclusiva di Bonaldo SpA. È vietata qualunque riproduzione o utilizzo delle immagini senza preventiva autorizzazione scritta di Bonaldo SpA.

Bonaldo SpA reserves the right to change, without any notice, materials, covers, finishes and drawings of the products presented in this catalogue. Colors and finishes shown are approximate and may differ from actual ones. All images in this catalogue are exclusive property of Bonaldo SpA. Every reproduction or use of the images without prior written authorization from Bonaldo SpA is therefore strictly forbidden.

Bonaldo SpA behält sich das Recht vor, ohne vorherige Ankuendigung, Materialien, Ersatzbezeuge, Ausfuehrungen und Zeichnungen der in diesem Katalog vorgestellten Produkte zu aendern. Die dargestellten Farben und Ausfuehrungen sind ungefaehre Angaben und koennen von den Originalen abweichen. Die in diesem Katalog abgebildete Bilder sind ausschliesslich Eigentum von Bonaldo SpA. Ohne die vorherige schriftliche Genehmigung von Bonaldo SpA. ist es jede Vervielfaeltigung oder Verwendung von Bildern verboten.

Bonaldo SpA se réserve le droit de modifier, sans préavis, les matériaux, les revêtements, les finitions et les dessins des produits présentés dans ce catalogue. Les couleurs et les finitions indiquées sont indicatives et peuvent différer des originaux. Les images reproduites dans ce catalogue sont propriété exclusive de Bonaldo SpA. Il est interdit la reproduction ou utilisation d'images sans l'autorisation écrite préalable de Bonaldo SpA.

Update 2017

WWW.BONALDO.IT

BONALDO

Bonaldo SpA _ via Straelle, 3 _
35010 Villanova di Camposampiero (PD) Italy
tel + 39 049.9299.011
bonaldo@bonaldo.it www.bonaldo.it

